



Growatt 4000MTLP-US
Growatt 5000MTLP-US
Growatt 6000MTLP-US
Growatt 7000MTLP-US
Growatt 7600MTLP-US

Shenzhen Growatt New Energy Technology CO.,LTD
Building B, Jiayu Industrial Zone,#28 Guanghui Road,
Longteng Community, Shiyao,Baoan District
Shenzhen, P.R.China

T + 86 755 2747 1942
F + 86 755 2747 2131
E info@ginverter.com
W www.growatt.com

Installation & Operation Manual

1 Information on this Document

- 1.1 Validity
- 1.2 Target Group
- 1.3 Storage of the manuals
- 1.4 Additional information
- 1.5 Symbols in this document

2 Safety

- 2.1 Intended Use
- 2.2 Qualification of skilled person
- 2.3 Safety instruction
- 2.4 Certified countries
- 2.5 DC and AC disconnect
- 2.6 Grounding the PV modules
- 2.7 Appropriated Usage
- 2.8 Operation Warnings

3 Product Description

- 3.1 Inverter Overview
- 3.2 Information of Label
- 3.3 Display Interface
- 3.4 Arc-Fault Circuit Interrupter
- 3.5 Optional additional function
- 3.6 Dimensions and weight
- 3.7 Transportation
- 3.8 Features

4 Inspection of delivery

- 4.1 Unpacking and inspection

Technical Advice / Application Assistance: +1 (903) 441-2090

5 Installation

- 5.1. Safety instruction
- 5.2. Selecting the Installation Location
- 5.3. Mounting the inverter

6 Electrical Connection

- 6.1. Safety
- 6.2. Intended Use
- 6.3. Overview of the connection area
- 6.4. Grounding
- 6.5. AC connection
- 6.6. DC connection
- 6.7. Communication connection

7 Commissioning

8 Display

- 8.1. LCD display
- 8.2. Setting the LCD display
- 8.3. Operation checking

9 Communication

- 9.1. Monitoring
- 9.2. Monitoring System

10 Startup and Shutdown of the inverter

- 10.1 Startup of the inverter
- 10.2 Turn off the Growatt MTLP-US

11 Cleaning and Care

- 11.1. Checking the inverter
- 11.2. Checking the DC disconnect
- 11.3. Cleaning the Inverter
- 11.4. Trouble shooting

12 Decommissioning

- 12.1. Dismantling the inverter
- 12.2. Packaging the inverter
- 12.3. Storage of inverter
- 12.4. Disposal

13 Operation Modes

- 13.1. Normal Mode
- 13.2. Fault Mode
- 13.3. Shutdown Mode

14 Protection

- 14.1. Altitude protect
- 14.2. Temperature protect
- 14.4. Arc detection protect and Operation

15 Growatt Warranty

16 Technical Data

- 16.1. Specification
- 16.2. Efficiency curve
- 16.3. Torque
- 16.4. Optional

17 Download address

18 Contact

Manual Introduce and Copyright

Copyright © 2014 Growatt New Energy Technology CO., LTD all rights reserved. No part of this document may be reproduced, stored in a retrieval system, or transmitted, in any form or by any means, electronic, mechanical, photographic, magnetic or otherwise, without the prior written permission of Growatt New Energy Technology CO., LTD.

Growatt New Energy Technology CO., LTD makes no representations, express or implied, with respect to this documentation or any of the equipment and/or software it may describe, including (with no limitation) any implied warranties of utility, merchantability, or fitness for any particular purpose. All such warranties are expressly disclaimed. Neither Growatt New Energy Technology CO., LTD nor its distributors or dealers shall be liable for any indirect, incidental, or consequential damages under any circumstances.

(The exclusion of implied warranties may not apply in all cases under some statutes, and thus the above exclusion may not apply.)

Specifications are subject to change without notice. Every attempt has been made to make this document complete, accurate and up-to-date. Readers are cautioned, however, that Growatt reserves the right to make changes without notice and shall not be responsible for any damages, including indirect, incidental or consequential damages, caused by reliance on the material presented, including, but not limited to, omissions, typographical errors, arithmetical errors or listing errors in the content material. All trademarks are recognized even if these are not marked separately. Missing designations do not mean that a product or brand is not a registered trademark.

Growatt New Energy Technology CO.,LTD
Building B,jjiayu industrial Zone,#28 Guanghui Road,Longteng
Community,Shiyan,
Banan District Shenzhen P.R.China

1.1 Validity

This manual describes the assembly, installation, commissioning and maintenance of the following Growatt inverters:

Growatt 4000MTLP-US

Growatt 5000MTLP-US

Growatt 6000MTLP-US

Growatt 7000MTLP-US

Growatt 7600MTLP-US

This manual does not cover any details concerning equipment connected to the Growatt inverter (e.g. PV modules). Information concerning the connected equipment is available from the Growatt of the equipment.

1.2. Target Group

 CAUTION	This manual is for qualified personnel. Qualified personnel have received training and have demonstrated skills and knowledge in the construction and operation of this device. Qualified personnel are trained to deal with the dangers and hazards involved in installing electric devices.
--	---

1.3. Storage of the manuals

The manual and other documents must be stored in a convenient place and be available at all times. We assume no liability for any damage caused by failure to observe these instructions.

1.4. Additional information





Find further information on special topics in the download area at www.growatt.com

Technical Advice / Application Assistance: +1 (903) 441-2090









1.5. Symbols in this document

1.5.1 Warnings in this document

A warning describes a hazard to equipment or personnel. It calls attention to a procedure or practice, which, if not correctly performed or adhered to, could result in damage to or destruction of part or all of Growatt equipment and/or other equipment connected to the Growatt equipment or personal injury.

Symbol	Description
 DANGER	DANGER indicates a hazardous situation which, if not avoided, will result in death or serious injury.
 DANGER	WARNING indicates a hazardous situation which, if not avoided, could result in death or serious injury.
 CAUTION	CAUTION indicates a hazardous situation which, if not avoided, could result in minor or moderate injury.
 NOTE	NOTICE is used to address practices not related to personal injury.
 Information	Information that you must read and know to ensure optimal operation of the system.

1.5.2 Markings on this product

Symbol	Description
	Warning regarding dangerous voltage The product works with high voltage. All work on the product must only be performed as described in its documentation.
	Beware of hot surface The product can become hot during operation. Do not touch the product during operation.
	Observe the operating instructions Read the product's documentation before working on it. Follow all safety precautions and instructions as described in the documentation.
	FCC certificate
	Transformer-less
	UL1741 Standard for Safety for Inverters, Converters, Controllers and Interconnection System Equipment for use with Distributed Energy Resources. CSA CSA-C22.2 No. 107.1-01 - General Use Power Supplies.
	Earth Ground
	DC current
	AC current

1.5.3 Glossary

- **AC**
Abbreviation for 'Alternating Current'
- **DC**
Abbreviation for 'Direct Current'
- **Energy**
Energy is measured in Wh (watt hours), kWh (kilowatt hours) or MWh (megawatt hours). The energy is the power calculated over time. If, for example, your inverter operates at a constant power of 20,000 W for half an hour and then at a constant power of 10,000 W for another half an hour, it has fed 15,000Wh of energy into the power distribution grid within that hour.
- **Power**
Power is measured in W (watts), kW (kilowatts) or MW (megawatts). Power is an instantaneous value. It displays the power your inverter is currently feeding into the power distribution grid.
- **Power Factor**
Power factor is the ratio of true power or watts to apparent power or volt amps. They are identical only when current and voltage are in phase than the power factor is 1.0. The power in an ac circuit is very seldom equal to the direct product of the volts and amperes. In order to find the power of a single phase ac circuit the product of volts and amperes must be multiplied by the power factor.
- **PV**
Abbreviation for photovoltaic
- **Wireless communication (opt)**
The external wireless communication technology is a radio technology that allows the inverter and other communication products to communicate with each other. The external wireless communication does not require line of sight between the devices and it is selective purchasing.

2.1. Intended Use

The Growatt MTLP-US inverter takes current from PV array and converts it to alternating current for the power distribution grid (F). Energy surplus may even result in the energy meter (E) of your plant running backwards. The inverter is suitable for indoor and outdoor use. The PV modules used must be suitable for use with the inverter and must be approved by the module manufacturer. Do not connect any energy sources other than PV modules to the Growatt MTLP-US inverter.

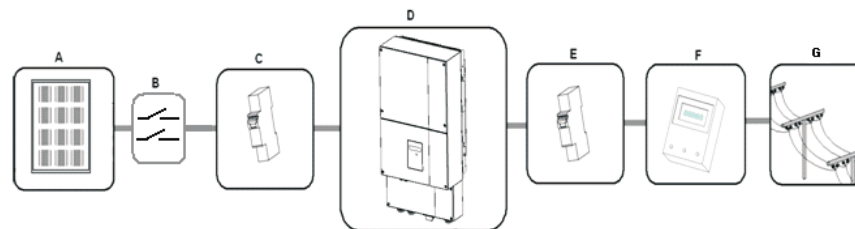

position	description
A	PV modules
B	Rapid shutdown system
C	DC load circuit breaker
D	Growatt MTLP-US Inverter
E	AC load circuit breaker
F	Energy meter
G	Utility grid

2.2. Qualification of skilled person

This grid-tied inverter system operates only when properly connected to the AC distribution network. Before connecting the services of Growatt MTLP-US to the power distribution grid, contact the local power distribution grid company.







This connection must be made only by qualified technical personnel, and may only install after receiving appropriate approvals, as required by the local authority having jurisdiction.



- Knowledge of how an inverter works and is operated.
- Experience in how to deal with the dangers and risks associated with installing and using electrical devices.
- Training in the installation and commissioning of electrical devices.
- Knowledge of all applicable standards and guidelines.
- Knowledge and adherence of this manual and all safety instructions.

Technical Advice / Application Assistance: +1 (903) 441-2090

2.3. Safety instruction

The Growatt MTLP-US Inverter is designed and tested according to international safety requirements (UL 1741/IEEE 1547); however, certain safety precautions must be observed when installing and operating this inverter. Read and follow all instructions, cautions and warnings in this installation manual. If questions arise, please contact Growatt's technical services at +86 (0)755 2747 1900.

	<p>Danger to life due to lethal voltages! Lethal voltages are present within the unit and on the power supply lines. Therefore, only authorized electricians may install and open the unit. Even when the unit is disconnected, high contact voltages may still be present within the unit.</p>
	<p>Danger of burn injuries due to hot enclosure parts! During operation, the four sides of the enclosure lid and the heat sink may become hot. Only touch the front enclosure lid during operation.</p>
	<p>Electric arc hazards The product has large electrical potential differences between its conductors. Arc flashes can occur through air when high-voltage current flows. Do not work on the product during operation.</p>
	<p>Risk of fire Improper installation of the product may cause a fire.</p>
	<p>Possible damage to health as a result of the effects of radiation! In special cases, there may still be interference for the specified application area despite maintaining standardized emission limit values (e.g. when sensitive equipment is located at the setup location or when the setup location is near radio or television receivers). In this case, the operator is obliged to take proper action to rectify the situation.</p> <p>Do not stay closer than 8inch to the inverter for any length of time.</p>
 <p>NOTE</p>	<p>Grounding the PV generator Comply with the local requirements for grounding the PV modules and the PV generator. Growatt recommends connecting the generator frame and other electrically conductive surfaces in a manner which ensures continuous conduction with ground these in order to have optimal protection of the system and personnel.</p>

	<p>NOTE</p> <p>permanent connection The inverter may only be operated with a permanent connection to the public power grid. The inverter is not intended for mobile use. Any other or additional use is not considered the intended use. The manufacturer/supplier is not liable for damage caused by such unintended use. Damage caused by such unintended use is at the sole risk of the operator</p>
	<p>NOTE</p> <p>Capacitive Discharge Currents PV modules with large capacities relative to earth, such as thin-film PV modules with cells on a metallic substrate, may only be used if their coupling capacity does not exceed 500nF. During feed-in operation, a leakage current flows from the cells to earth, the size of which depends on the manner in which the PV modules are installed (e.g. foil on metal roof) and on the weather (rain, snow). This 'normal' leakage current may not exceed 50mA due to the fact that the inverter would otherwise automatically disconnect from the electricity grid as a protective measure.</p>

2.4. Certified countries

With the appropriate settings, the unit will comply with the requirements specified in the following standards and directives.

- UL 1741
- IEEE 1547
- CSA C22.2 No.107.1-1
- FCC Part15
- UL1699B

Growatt can preset special grid parameters for other countries installation locations according to customer requests after evaluation by Growatt. You can make later modifications yourself by changing software parameters with respective communication products. To change the grid-relevant parameters, an access code is required; please contact Growatt support if needed.

Technical Advice / Application Assistance: +1 (903) 441-2090

2.5. DC and AC disconnect

Isolate the Growatt MTLP-US Inverter securely from the grid and the PV generators using DC and AC Switch. DC and AC Switch shall be able to disconnect all ungrounded conductors after installation.

2.6. Grounding the PV modules

The Growatt MTLP-US series product is a transformer-less inverter and has no galvanic separation. Therefore, the inverter may only be operated with ungrounded PV array. Do not ground the DC circuits of the PV modules connected to the Growatt MTLP-US inverter as it must comply with National Electric Code, Article 690.35 'Ungrounded Photovoltaic Power Systems' and local regulations for ungrounded systems. Only ground the mounting frame of the PV modules. If you connect a grounded PV array to the Growatt MTLP-US Inverter, the error message 'PV ISO LOW' will appear on display.

2.7. Appropriate Usage

The Growatt Inverter converts DC Current from PV generator into AC current. The inverter is suitable for mounting indoors and outdoors.

You can use the AC current generated as follows:



House grid:	Energy flows into the house grid. The load (i.e. household devices or lighting) consume the energy. The energy left over is fed into the public grid. When the Growatt is not generating any energy (e.g. night time), the consumers which are connected are supplied by the public grid. The Growatt does not have its own energy meter. When energy is fed into the public grid, the energy meter spins backwards.
Public grid:	Energy is fed directly into the public grid. The Growatt is connected to a separate energy meter. The energy produced is compensated at a rate depending on the electric power company.

Persons with limited physical or technical abilities may only work with the inverter following proper instruction and under constant supervision. Keep children away from inverter and components!

2.7.1 Assembly Warnings

 WARNING	Prior to installation, inspect the unit to ensure absence of any transport or handling damage, which could affect insulation integrity or safety clearances; failure to do so could result in safety hazards.
	Assemble the inverter per the instructions in this manual. Use care when choosing installation location and adhere to specified cooling requirements.
	Unauthorized removal of necessary protections, improper use, incorrect installation and operation may lead to serious safety and shock hazards and/or equipment damage.
	In order to minimize the potential of a shock hazard due to hazardous voltages, cover the entire solar array with dark material prior to connecting the array to any equipment.

2.7.2 Electrical Connection Warnings

 WARNING	Make all electrical connections (e.g. conductor termination, fuses, PE connection, etc.) in accordance with prevailing regulations. When working with the inverter powered on, adhere to all prevailing safety regulations to minimize risk of accidents.
	Systems with inverters typically require additional control (e.g., switches, disconnects) or protective devices (e.g., fusing circuit breakers) depending upon the prevailing safety rules.
 DANGER	The components in the inverter are live. Touching live components can result in serious injury or death. <ul style="list-style-type: none"> • Do not open the inverter except the wire box by qualified persons. • Electrical installation, repairs and conversions may only be carried out by electrically qualified persons. • Do not touch damaged inverters. Danger to life due to high voltages in the inverter <ul style="list-style-type: none"> • There is residual voltage in the inverter. The inverter takes 20 minutes to discharge • Wait 20 minutes before you open the wire box.

2.8 Operation Warnings

 WARNING	Anytime the inverter has been disconnected from the power network, use extreme caution as some components can retain charge sufficient to create a shock hazard; to minimize occurrence of such conditions, comply with all corresponding safety symbols and markings present on the unit and in this manual.
	Ensure all covers and doors are closed and secure during operation.
	All operations regarding transport, installation and start-up, including maintenance must be operated by qualified, trained personnel and in compliance with all prevailing codes and regulations.
	Although designed to meet all safety requirements, some parts and surfaces of Inverter are still hot during operation. To reduce the risk of injury, do not touch the heat sink at the back of the PV-Inverter or nearby surfaces while Inverter is operating.
	Incorrect sizing of the PV plant may result in voltages being present which could destroy the inverter. The inverter display will read the error message 'PV-Over voltage'. Turn the rotary switch of the DC Disconnect to the Off position immediately. Contact installer.

3.1 Inverter Overview

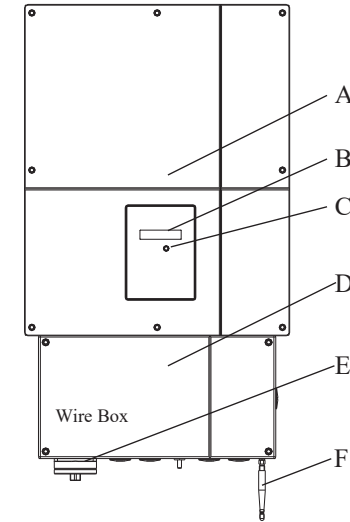

Position	Description
A	Upper enclosure
B	LCD
C	LED
D	Wire box enclosure
E	DC disconnect
F	antenna

Technical Advice / Application Assistance: +1 (903) 441-2090

3.1.1 Communication Interface

The inverter can be fitted with a communication interface (e.g. RS485 or Ethernet or Zigbee or 3G function). This communication interface enables the inverter to communicate with Growatt communication products or other inverters.

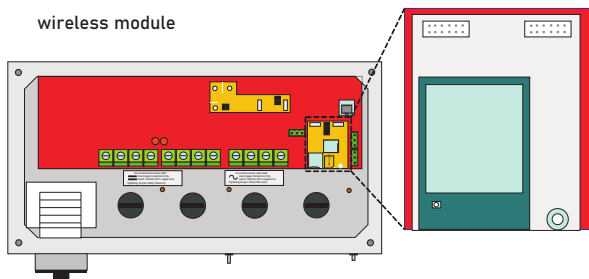
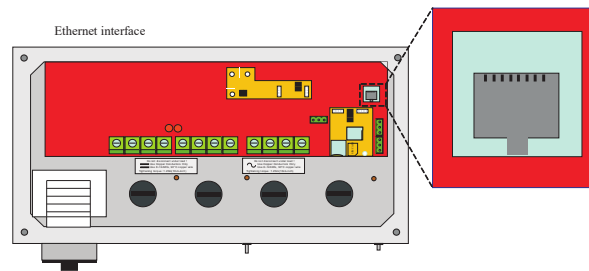
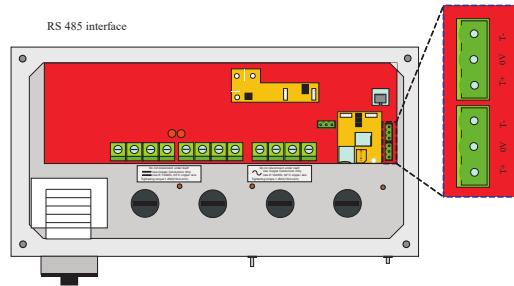

3.2. Information of Label

The labels provide technical information of the inverter. You can identify the inverter by the label, it is located on the enclosure of the inverter.

- The type of product (Type/Model)
- Device-specific characteristics
- Specifications of the inverter
- Requirements of cable & torque
- AFCI certificates
- Serial number
- Warning

3.2.1 Product's Labels

➤ Label Information show as

Section	Parameter	Value
Manufacturer	Manufacturer	GROWATT
	Product Name	PV Grid Inverter
Input parameters	Model Name	GROWATT 5000MTLP-US
	Range of input voltage:	100 ~ 600Vdc
	Max. input voltage:	600Vdc
	Max. input current of the MPP tracker:	18Ade/18Ade
	Max. input short circuit current :	28Ade/28Ade
Output parameters	Nominal output power:	5000W
	Default grid voltage setting:	240Vac Split Phase
	Nominal grid voltage:	208Vac / 240Vac / 277Vac
	Range of grid voltage:	183 ~ 228Vac @ 208Vac 211 ~ 264Vac @ 240Vac 244 ~ 305Vac @ 277Vac
	Nominal grid frequency :	60Hz
	Range of grid frequency :	59.5 ~ 60.5Hz
	Grid voltage and frequency trip times:	<150ms@V<45%Un/v>120%Un,F<57Hz/F>62Hz
	Nominal output current:	21A
	Max. output overcurrent protection:	26A
	Output power factor :	0.99
Protection & Certificates	Enclosure:	Type 4X
	Operation Ambient Temperature:	-25~+60°C (Power derating above 45°C)
	Inverter type:	Utility interactive transformer-less inverter
	Conforms to UL STD.1741	
	Certified to CSA STD.C22.2 No.107.1	

Intertek 4007184 Made in China

Technical Advice / Application Assistance: +1 (903) 441-2090

➤ Serial number label



Serial number Information show as

X	X	X	X	X	X	X	X	X	X	X	X	X
Product Code	Version	Year	Week	Serial number by weak 0001~9999				ODM or OEM	Warranty year F(5) T(10)			

3.2.2 Warning Label

➤ AFCI label

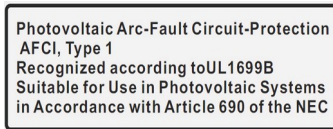

➤ Warning label



3.2.3 Labels in the wire box

➤ Cables & torque

Do not disconnect under load!

— Use Copper Conductors Only
 --- Use 8~12AWG, 90°C copper wire
 Tightening torque: 1.2Nm(10Lb-inch)

~ Use Copper Conductors Only
 Use 8~12AWG, 90°C copper wire
 Tightening torque: 1.2Nm(10Lb-inch)

3.3. Display Interface

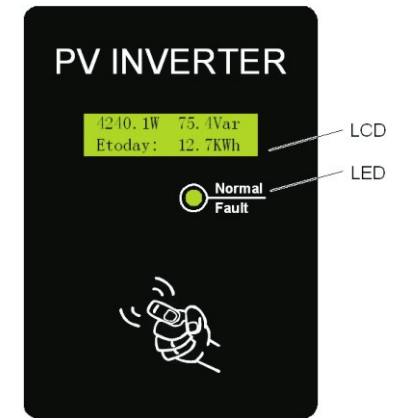

3.4. Arc-Fault Circuit Interrupter

In accordance with the National Electrical Code®, Article 690.11, the inverter has a system for the recognition of electric arc detection and interruption. An electric arc with a power of 300 W or greater must be interrupted by the AFCI within the time specified by UL 1699B. A tripped AFCI can only be reset manually. You can deactivate the automatic arc fault detection and interruption (AFCI) via a communication product in 'Installer' mode if you do not require this function. The 2011 edition of the National Electrical Code®, Section 690.11 stipulates that newly installed PV systems attached to a building must be fitted with a means of detecting and disconnecting serial electric arcs (AFCI) on the PV side.

3.5. Optional additional function

Inverter provide integrated power meter PCBA solution. The solution has an accuracy of 0.5%, Max current of 50 Arms, Calibration current of 5A. Using Sunspec wireless communication protocol, it transmits data like W, Var, VA, kWh, kWh to internet server.

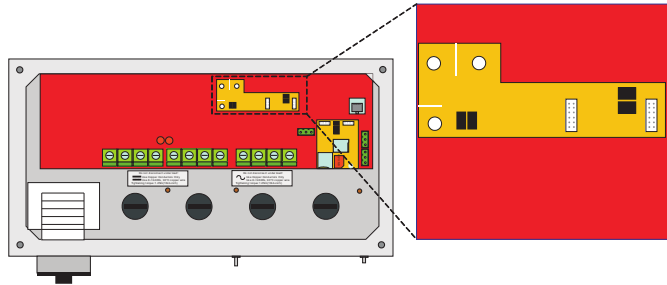

3.7. Transportation

The inverter is thoroughly tested and strictly inspected before delivery. Our inverters leave our factory in proper electrical and mechanical condition. Special packaging ensures safe and careful transportation. However, transport damage may still occur. The shipping company is responsible in such cases. Thoroughly inspect the inverter upon delivery. Immediately notify the responsible shipping company if you discover any damage to the packaging which indicates that the inverter may have been damaged or if you discover any visible damage to the inverter. We will be glad to assist you, if required. When transporting the inverter, the original or equivalent packaging should be used, and the maximum layers for original carton is six, as this ensures safe transport.

3.8. Features

- DSP controller
- Multi MPP controller
- Sound control
- Easy installation
- Integrated wire box
- Integrated DC switch
- CEC efficiency of 97.0%
- Maximum efficiency of 97.5%
- Wide input voltage range from 100-600V
- Adapt to multi grid model(208Vac/240Vac/277Vac)
- Multi communication pattern optional
- Reactive power regulate function optional(Default PF>0.99)
- Integrated smart meter optional

3.6. Dimensions and weight

Model	Height (H)	Width (W)	Depth (D)	Weight
4000 MTLP-US	730mm (28.94in)	400 mm (15.75in)	215mm (8.46in)	31.5Kg (69.44Lb)
5000 MTLP-US				
6000 MTLP-US				
7000 MTLP-US				
7600 MTLP-US				32Kg (70.55Lb)

4 Unpacking

4.1. Unpacking and inspection

Thoroughly inspect the packaging upon received. If any damage to the carton is visible, or if you find that the inverter unit is damaged after unpacking, please notify the shipping company and Inverter supplier immediately.

Check the delivery for completeness and for visible external damage of the inverter. If there is anything damaged or missing, please contact your supplier. Do NOT dispose of the original package. If you want to transport the inverter, it is best to transport the inverter in the original package.

Components included:

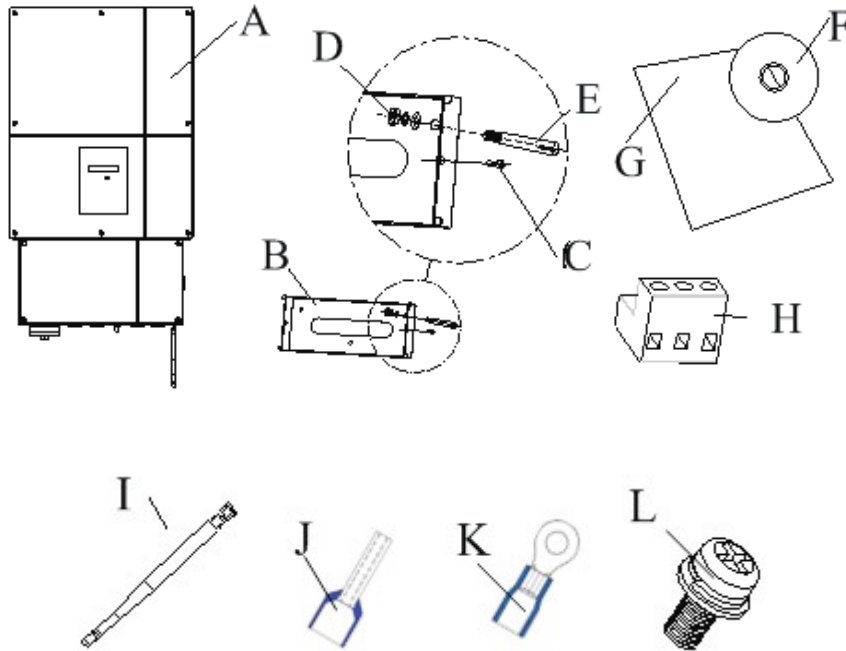

Complete delivery should contain as follows:

Item	description	Quantity
A	inverter	1
B	Mounting frame	1
C	Safety-lock screws	2
D	Mounting screws	3
E	Mounting frame screws sleeve	3
F	Monitor software(disk)	1(Optional)
G	Manual	1
H	Rs485 connectors	2
I	Antenna	1(inverter)
J	cord end terminal	13
K	ring terminal	1 or 3
L	M4 screw	1 or 3

	<p>NOTE Though the packaging of Growatt is durable, please treat the packing box gently and avoid disposing of the packing box. In this package, there are inverter cystosepiment and carton from inside to outside.</p>
---	---

5 Instruction

5.1. Safety instruction

 <p>DANGER</p>	<p>Danger to life from electric shock due to high voltages High voltages are present in the DC cables and later during operation in the conductive components of the inverter. These can cause fatal electric shocks.</p>
---	---

 <p>DANGER</p>	<p>Danger to life due to fire or explosion This product operates at high voltages and despite careful construction, electrical devices can cause fires. Do not install the inverter on easily flammable materials and where flammable materials are stored.</p>
---	---

 <p>WARNING</p>	<p>Risk of burns due to hot surfaces The surface of the inverter can become very hot. Touching the surface can result in burns. Do not touch hot surfaces. During operation, do not touch any parts other than the lower enclosure lid of the inverter. Mount the inverter in such a way that it cannot be touched inadvertently.</p>
--	---

	<p>The diameter of the drill holes must correspond to the fasteners that you use for mounting the inverter.</p> <p>Mounting on a concrete wall The diameter of the hole must be the same as the outer diameter of the screw anchors. Insert suitable screw anchors into the drill holes.</p> <p>Mounting on a wall with wooden support posts The diameter of the hole must correspond to the screw diameter used. The screws should be stainless steel. The diameter of the screws must correspond to the diameter of the holes in the wall mounting bracket.</p>
---	---

5.2. Selecting the installation location

This is guidance for installer to choose a suitable installation location, to avoid potential damages to device and operators. Rain-tight or wet location hubs that comply with the requirements in the Standard for Conduit, Tubing, and Cable Fittings, UL 514B, are to be used.

- The unit shall be mounted at least 36inch (3 feet) above the ground. The installation location must be suitable for the inverter's weight and dimensions for a long period time.
- Select a wall or solid vertical surface that can support the PV-Inverter.
- Select the installation location so that the status display can be easily viewed.
- Select a well-ventilated location sheltered from direct sunlight and rain.
- Do not install the inverter on structures constructed of flammable or thermolabile materials.
- The humidity of the installation location should be 0~100% without condensation.
- The installation location must be freely and safely to access at all times.
- When possible, mount the inverter vertically or tilted backwards by max. 15°. And make sure the connection of inverter must be downwards. Never install horizontal and avoids forward and sideways tilt.

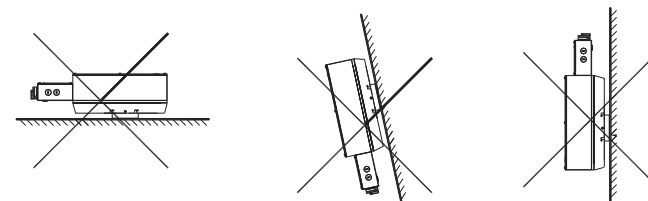
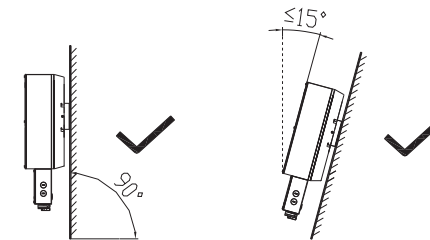

- Be sure that the inverter is out of the children's reach.
- Don't put any things on the inverter. Do not cover the inverter.
- The location shall be away from strong electromagnetic interference.
- Don't install the inverter near television antenna or any other antennas, antenna cables.
- Providing better ventilation for the inverter to ensure the heat escape adequately. The ambient temperature should be below 40°C (104°F) to ensure optimum operation. Please make sure the inverter is installed at the right place. The inverter can't install close to trunk.

Technical Advice / Application Assistance: +1 (903) 441-2090

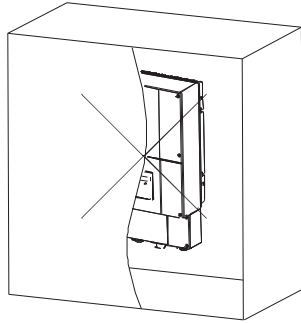

- The location shall not exceed Type 4X standard according to ANSI/IEC_60529-2004. (The bottom knock off holes need protection)
- Do not install inverter exposed to direct sunlight, or rain gutters. We suggest that the inverters should be installed at the location with some cover or protection.

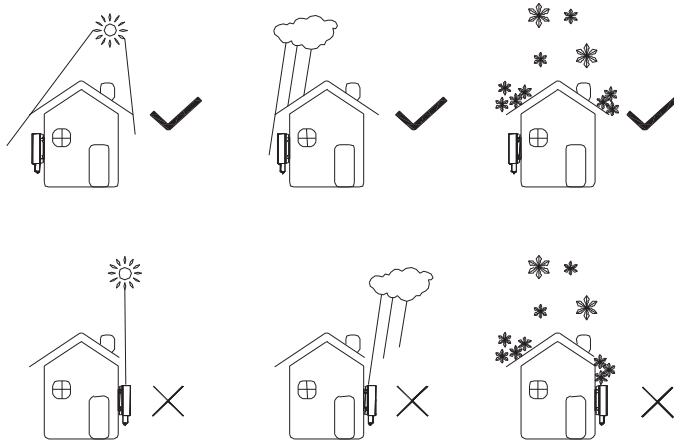

- Observe the minimum clearances to walls, other inverters or objects as shown in the diagram below in order to guarantee sufficient heat dissipation.

Direction	Min. clearance
above	30cm(11.81in)
below	50cm(19.69in)
sides	30cm(11.81in)
front	30cm(11.81in)

Ambient dimensions of one inverter

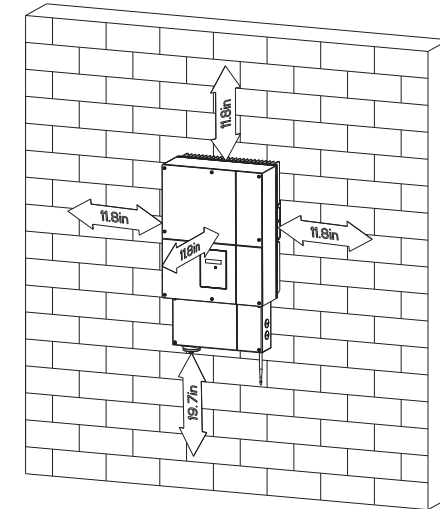

Ambient dimensions of a series inverters

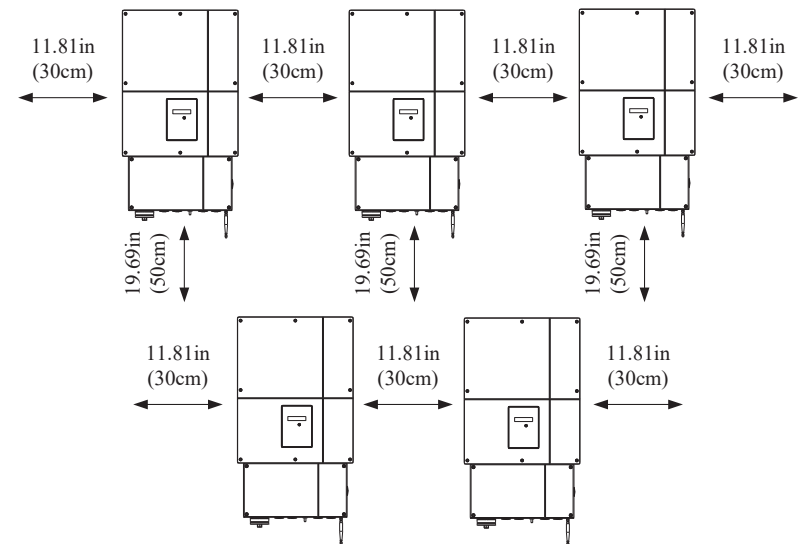

- There must be sufficient clearance between the individual inverters to ensure that the cooling air of the adjacent inverter is not taken in.
- If necessary, increase the clearance spaces and make sure there is enough fresh air supply to ensure sufficient cooling of the inverters.

5.3. Mounting the inverter

5.3.1 Preparatory work

i	<p>➤ General tools</p> <ul style="list-style-type: none"> • Personal safety equipment such as gloves, helmet, goggles, ear plugs, safety harness etc. • Step ladders. • Knife. <p>➤ Tools for mechanical installation</p> <ul style="list-style-type: none"> • Equipment for transporting and lifting the inverter. • Electric (hammer) drill. • Hammer. • Set of drill bits, wrenches, sockets and screw bits. • Socket driver, screwdriver. • Tape measure. • level. • Pencil or other marker. • Fastening screws, plugs, etc.
----------	--

5.3.2 Dimensions of the mounting bracket

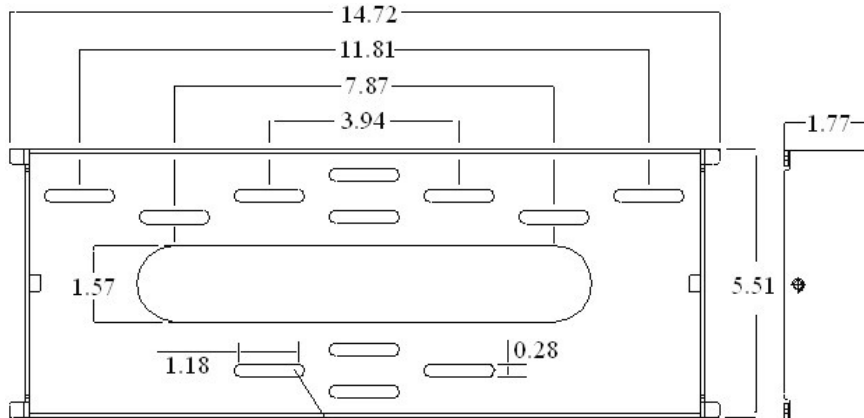

Units: inch

fix the bracket with M6x60 expansion bolt

5.3.3 Possibilities for Mounting the Wall Mounting Bracket

➤ **Mounting on a concrete wall**

Using the mounting frame as a template, drill holes as illustrated in image:

Hole size: 0.31 * 2.0inch/8*50mm (diameter) *(depth, at least), then insert 3 explosion bolts into the holes, make sure the bolts paralleled with the outer surface of the bracket. one screw on the upper left side, one screw on the upper right side, and third screw on the below.

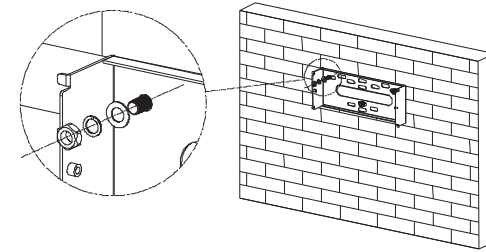

➤ **Mounting on a wooden wall with supporting post or on a pillar**

Using the mounting frame as a template, drill holes as illustrated in image:

The screws must be long enough to reach a depth in the wall of 11 1/2 inch, two screws at the upper middle, and third screw on the below.

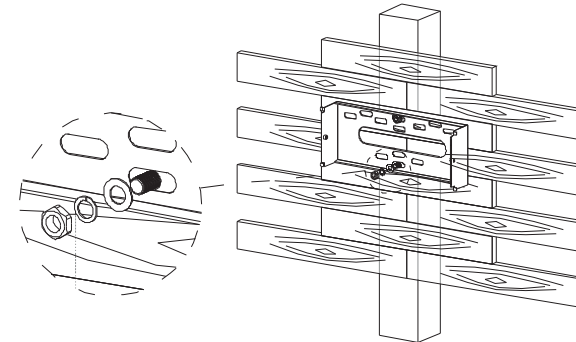

➤ **Mounting on a wooden wall with two supporting posts**

Using the mounting frame as a template, drill holes as illustrated in image:

The screws must be long enough to reach a depth in the wall of 11 1/2 inch, two screws at the upper left side, two screw on the upper right side.

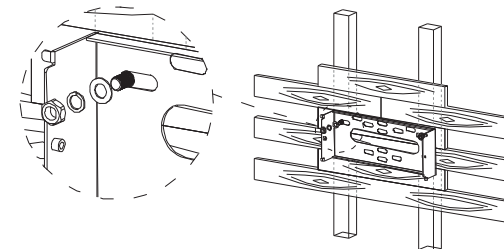

➤ Install the mounting frame as the figure shows. Do not drill the screws to be flush to the wall. Instead, leave 2 to 4mm exposed.

5.3.4 Mounting the inverter on a wall

 WARNING	<p>Falling equipment can cause serious or even fatal injury, never mount the inverter on the bracket unless you are sure that the mounting frame is really firmly mounted on the wall after carefully checking.</p>
---	---

- Lift up the inverter (heavy) over the bracket. Hang the inverter on the bracket, ensure that the inverter is securely hooked on to the bracket.

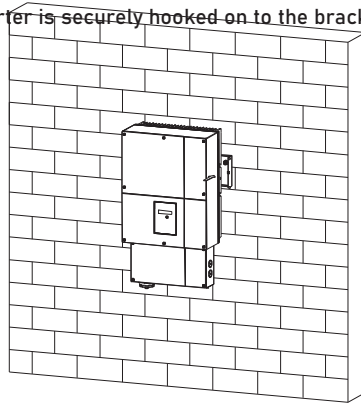

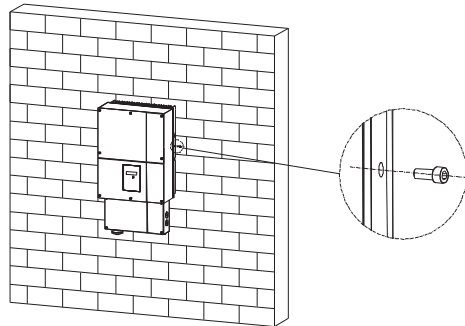

- Once the inverter is mounted properly, fasten four M6 safety-lock socket head cap screws on the left and right side firmly to prevent the inverter from being lifted off the bracket.





5.3.5 Check inverter installation status

- Check the upper straps of inverter and ensure it fits on to the bracket.
- Check the secure mounting of the inverter by trying to raise it from the bottom. The inverter should remain firmly attached.
- The Growatt MTLP-US is mounted.

6.1. Safety

 DANGER	<p>Danger to life from electric shock due to high voltages. High voltages are present in the DC cables and later during operation in the conductive components of the inverter. These can cause fatal electric shocks.</p> <p>Before connecting, make sure the AC & DC disconnect is turned off and measure the voltage within the limits of system.</p>
	<p>Electric shock hazard, the DC conductors of this photovoltaic system are normally ungrounded but will become intermittently grounded without indication when the inverter measures the PV array isolation.</p> <p>Because of the transformer less design, the DC positive pole and DC negative pole of PV arrays are not permitted to be grounded.</p>
	<p>Do not disconnect the DC connectors under load!</p>
 WARNING	<p>Risk of burns due to hot surfaces</p> <p>The surface of the inverter can become very hot. Touching the surface can result in burns. Do not touch hot surfaces. During operation, do not touch any parts other than the lower enclosure lid of the inverter. Mount the inverter in such a way that it cannot be touched inadvertently.</p>
 DANGER	<ol style="list-style-type: none"> 1. All electrical installations shall be done in accordance with the local and national electrical codes. Do not remove the casing. Inverter contains no user serviceable parts. Refer servicing to qualified service personnel. All wiring and electrical installation should be conducted by a qualified service personnel. 2. Carefully remove the unit from its packaging and inspect for external damage. If you find any imperfections, please contact your local dealer. 3. Be sure that the inverters connect to the ground in order to protect property and personal safety. 4. The inverter must only be operated with PV generator. Do not connect any other source of energy to it.

 <p>DANGER</p>	<ol style="list-style-type: none"> 5. Both AC and DC voltage sources are terminated inside the PV Inverter. Please disconnect these circuits before servicing. 6. This unit is designed to feed power to the public power grid (utility) only. Do not connect this unit to an AC source or generator. Connecting Inverter to external devices could result in serious damage to your equipment. 7. When a photovoltaic panel is exposed to light, it generates a DC voltage. When connected to this equipment, a photovoltaic panel will charge the DC link capacitors. 8. Energy stored in this equipment's DC link capacitors presents a risk of electric shock. Even after the unit is disconnected from the grid and photovoltaic panels, high voltages may still exist inside the PV-Inverter. Do not remove the casing until at least 5 minutes after disconnecting all power sources. 9. Although designed to meet all safety requirements, some parts and surfaces of Inverter are still hot during operation. To reduce the risk of injury, do not touch the heat sink at the back of the PV-Inverter or nearby surfaces while Inverter is operating.
 <p>WARNING</p>	<p>Danger of damage to electronic components due to electrostatic discharge.</p> <p>Take appropriate ESD precautions when replacing and installing the inverter.</p>
 <p>WARNING</p>	<p>Before connecting the power cables, you must connect both ground wire of DC and AC side in wire box first.</p>

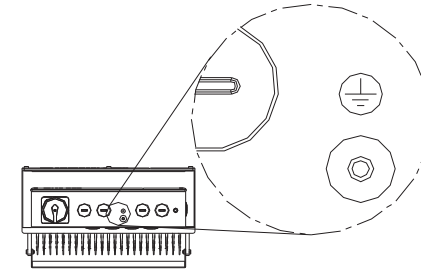

➤ Connecting the second protective conductor

- If the installation requires, the earth terminal can be used to connect a second protective conductor or as equipment bonding. This prevents touch current if the original protective conductor fails.



Model second protective Ground

Electrical installations

	<p>All electrical installations must be done in accordance with all local electrical codes and the NATIONAL Electrical Code®, ANSI/NFPA 70. For installation in Canada the installations must be done in accordance with applicable Canadian standards. Before connecting the inverter to the power distribution grid, contact your local electric utility company. This connection may be made only by electrically qualified persons.</p>
	<p>Tools for electrical installation</p> <ul style="list-style-type: none"> • Hexagonal driver 3mm for securing the front cover and AC connector. • Flat screwdriver 3mm for releasing spring terminals. • Cable and wire strippers. • Side cutters. • Crimping tool and cable lugs. • Cable marking equipment. • Digital multi-meter (insulation tester) with DC and AC sensitive current clamp, voltage measurement (max. 1000 VDC) and continuity testing functions.

6.2. Intended Use

The unit converts the DC (Direct Current) generated by the photovoltaic (PV) modules to grid-compliant AC (Alternating Current) and feed-in into the electricity grid. Growatt inverters are built according to all required safety rules. Nevertheless, improper use may cause lethal hazards for the operator or third parties, or may result in damage to the units and other property.

- This unit or system is provided with fixed trip limits and shall not be aggregated above 30 kW on a single Point of Common Connection.
- PV Panel: Provide DC power to inverter. If using MTL series PV inverter With Arc fault current detection function, we recommend consumer connect the Tracker A and Tracker B to different PV module strings.
- Converts DC (Direct Current) power from PV panel to AC (Alternating Current) power. Because Inverter is grid-connected, it controls the current amplitude according to the PV module power supply. Inverter always tries to convert the maximum power from your PV module.
- Connection system: This 'interface' between Utility and PV inverter may consist of electrical breaker, fuse and connecting terminals. To comply with local safety standards and codes, the connection system should be designed and implemented by a qualified technician.
- Utility: Referred to as 'grid' in this manual, is the way your electric power company provides power to your place.

6.3.3 Communication connection area

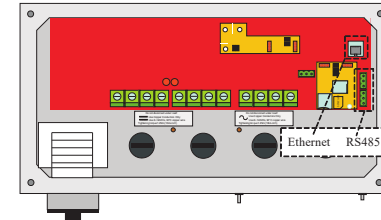

6.4. Grounding

AC Grounding

The Growatt MTLP-US must be connected to the AC grounding conductor of the power distribution grid via the ground terminal (PE).

The AC input and AC output circuits are isolated from the enclosure and system grounding, if required by Section 250 of the National Electrical Code, ANSI/NFPA 70.

Inverter

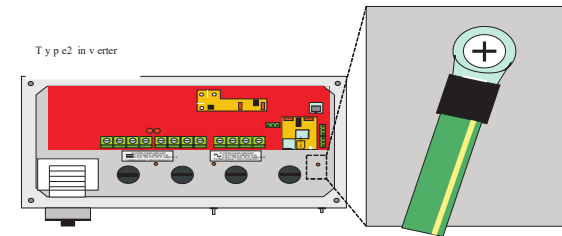

Grounding Electrode Terminal (GET)

A grounding electrode terminal may be required to local regulations.

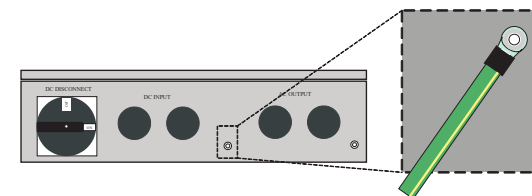

6.3. Overview of the connection area

6.3.1 AC connection area

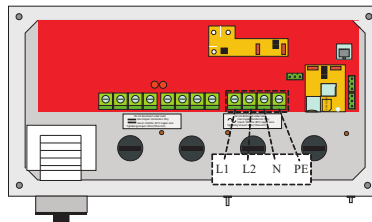

6.3.2 DC connection area

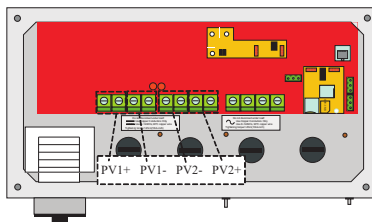

Technical Advice / Application Assistance: +1 (903) 441-2090

DC Grounding

Grounding of photovoltaic components (e.g., solar module frames)

The ground for photovoltaic components such as solar module frames must be connected at the grounding terminals. The size of the wire usually corresponds to the largest wire in the DC system.

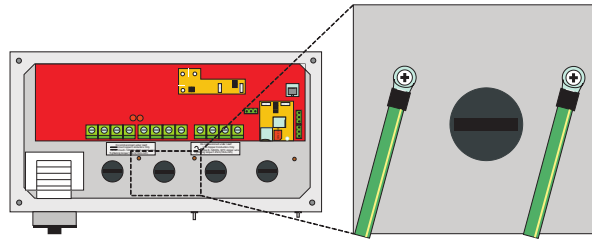

6.5. AC connection

6.5.1. Cable requirements

 NOTE	Use only solid or stranded wire but not fine stranded wire.
	Use cables with high ambient temperatures.
	Use cables with a large cross-section.

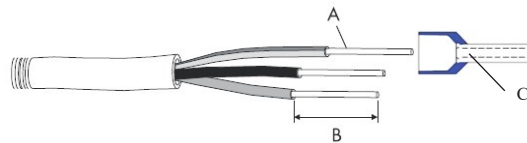

Code	Name	Detail
A	Conductor cross-section	Conductor cross section as follows table
B	Stripping insulation	0.32 ~0.47 in (8~12mm)
C	cord end terminal	KST E4010 or E6012

Conductor cross-section

Product Model	Max. current	Area(mm ²)	AWG No.
4000MTLP-US	16.7A	2.0~3.3	14~12
5000MTLP-US	21A	3.3~5.2	12~10
6000MTLP-US	25A	5.2~8.3	10~8
7000MTLP-US	29A	5.2~8.3	10~8
7600MTLP-US	31.7A	5.2~8.3	10~8

6.5.2 Grid standard

Before wiring the inverter, the installer needs to determine the grid configuration that the inverter will be connected to. The inverter is default set for utility interconnection with 240Vac Split-phase from factory. However, you can choose the Net MODEL through the LCD to set the inverter to be fitted to the most commonly used utility configuration types shown in the figure 6.5.1.

Based on the local grid standards, it is possible to select different connection types. The available configurations are shown in the following table:

Grid																
	240Vac Split-phase				208Vac 3phase-Δ				240Vac 3phase-Δ				277Vac 3phase-Y			
Grid type	Grid T1:240V(Default)				Grid T2:208V(Optional)				Grid T3:240V(Optional)				Grid T4:277V(Optional)			
terminal	1	2	3	4	1	2	3	4	1	2	3	4	1	2	3	4
wiring	L1	L2	N	PE	L1	L2	-	PE	L1	L2	-	PE	L1	N	-	PE

Figure 6.5.1

Technical Advice / Application Assistance: +1 (903) 441-2090

6.5.3. Single inverter System Installation

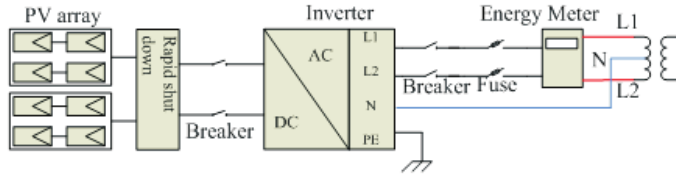

For 240 split phase

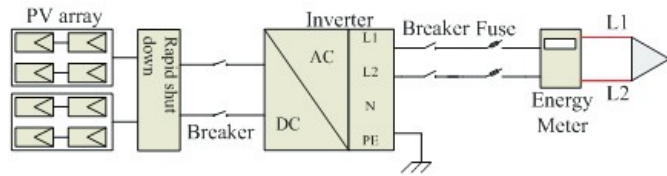

For 208/240V delta 3-phase

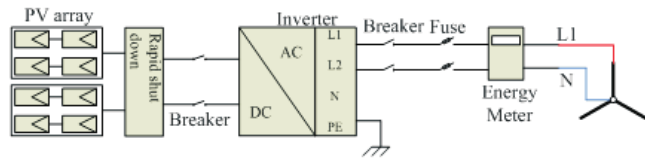

For Y 277V 3-phase

6.5.4. Multi inverters System Installation

If you are connecting to a 3-phase grid and are using a single phase inverter. Please refer to wiring diagram below, it is suggested to balance power between phases.

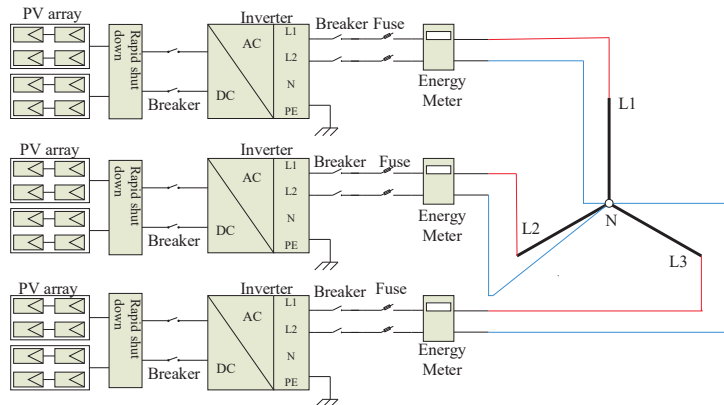

For Y 277V 3-phase

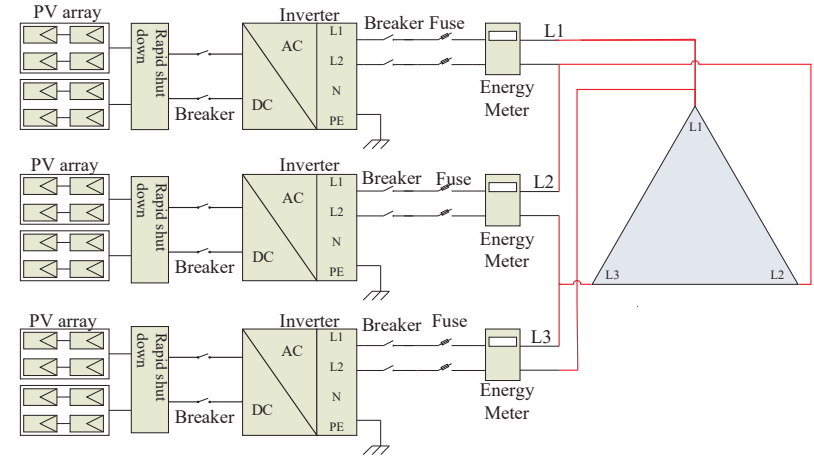

For 208/240V delta 3-phase

6.5.5. Connecting to the grid (AC utility)

- Check the grid (AC utility) configuration type. If your grid standard is not the factory default type, you must wire the local AC grid according with the figure 5.6.3. After wiring both DC input and AC output, you can use the LCD to choose the NET model to make the inverter suited for the local grid type in chapter 8.2 'Setting the LCD display'.
- You must install a separate AC circuit-breaker or other load disconnection unit between the inverter and utility, in order to ensure that the inverter can be safely disconnected under load.

 WARNING	<p>The separate disconnection unit spec require as follow:</p> <p>Voltage: the voltage much not less than the AC grid voltage which you connection.</p> <p>Current: the current much not less than 1.5 times of the inverter max output current which defined in the inverter spec.</p>
--------------------	---

Advised AC current breaker/switch:

Model	4000MTLP-US	5000MTLP-US	6000MTLP-US	7000&7600MTLP-US
Switch	25A/400Vac	32A/400Vac	40A/400Vac	50A/400Vac

Technical Advice / Application Assistance: +1 (903) 441-2090

1. Open the AC separate unit (disconnect) between the inverter and utility and the DC disconnect on the inverter.

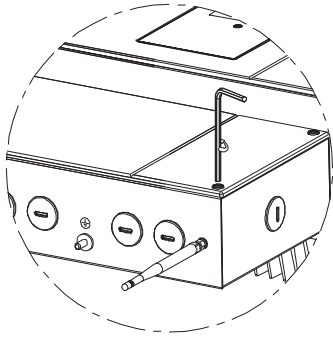

2. Open the wire box cover and the knock-out hole.

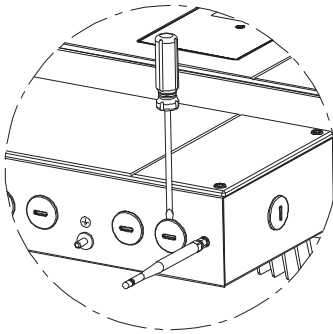

3. Install a rubber pipe into the knock-out hole and fasten the pipe nut, feed the cables through the pipe into the wire box till the terminal.

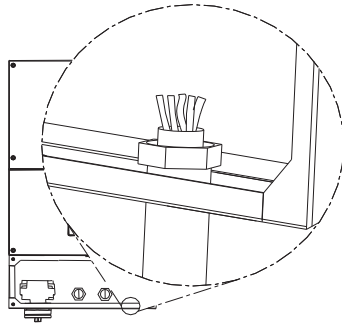

4. Remove protective cover

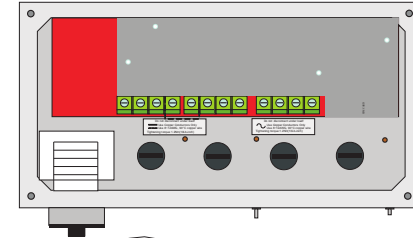

5. Connect the AC cables into relevant terminals as follow.

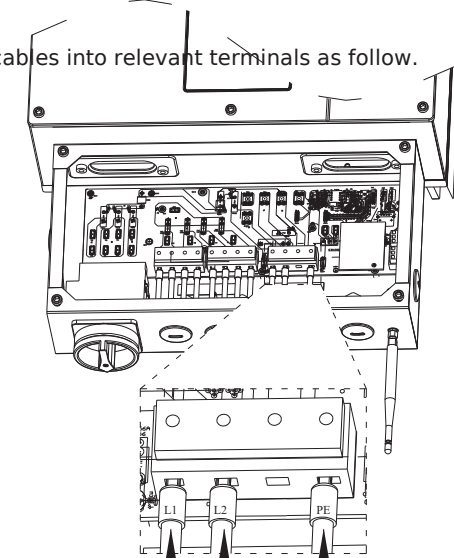

6.6. DC connection

	Use only solid or stranded wire but not fine stranded wire.
	Use cables with high ambient temperatures.
	Use cables with a large cross-section.

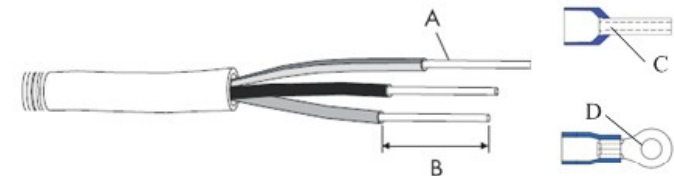

Technical Advice / Application Assistance: +1 (903) 441-2090

Code	Name	Detail
A	Conductor cross-section	Conductor cross section as follows table
B	Stripping insulation	10~12mm(0.32-0.47 inch)
C	cord end terminal	Example: KST E4010 or E6012
D	ring terminal	Example : KST RVBL5-5 or RNB5-5

Conductor cross-section

Product Model	Max. current	Area(mm ²)	AWG No.
MTLP-US	20A	3.3~5.2	12~10

The PV cables length should not exceed 50m (164ft), the resistance of the cable will consume inverter output power and reduce the inverters efficiency.

There are two MPP trackers featured in the Growatt MTLP-US series, so you can connect two independent MPP channels.

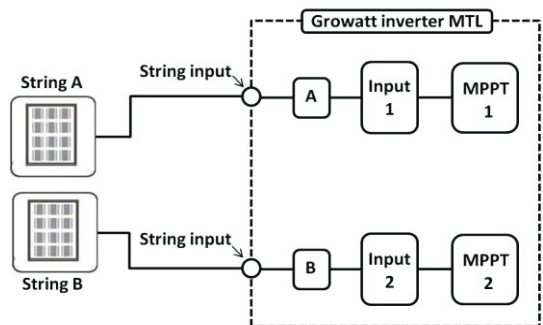

➤ Suggestions for the PV modules of the connected strings:

- ◇ Same type
- ◇ Same quantity of PV modules connected in series

➤ Wiring inverter in parallel

The inverter can be connected in parallel in order to obtain more power, each inverter shall connect to its own PV array, cannot connect a single PV array to more than one inverter. That will cause the inverter to work abnormally, the inverter will be damaged.

NOTE: For inverters with AFCI function; if tracker A and tracker B connect to same string PV module, it may misinform of an AFCI fault.

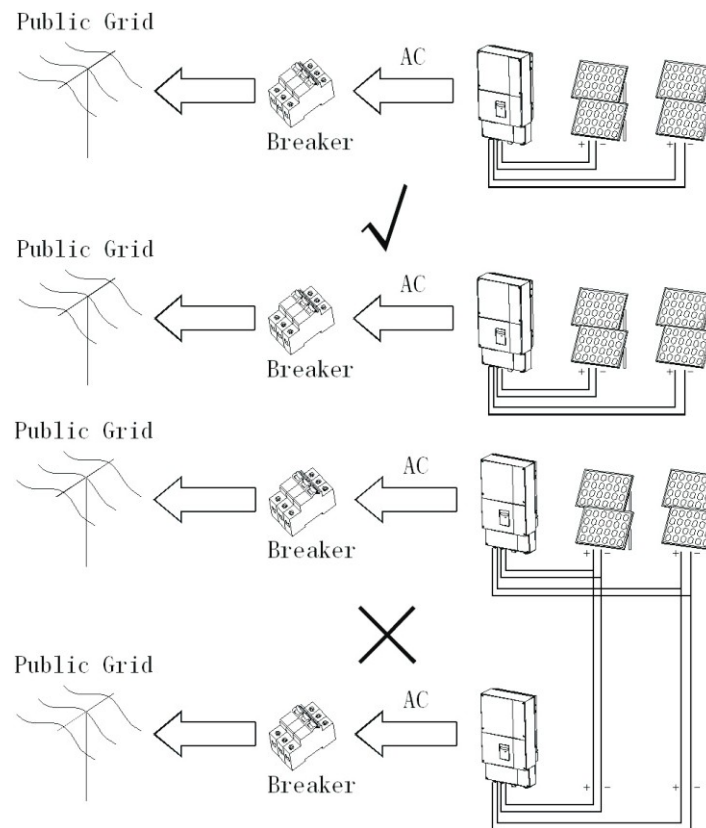

- Under any condition! Make sure the maximum open circuit voltage (Voc) of each PV string is less than 600Vdc.
- ◇ Do not connect strings with an open circuit voltage greater than the Max. input voltage of the inverter. If the strings voltage exceeds the Max. input voltage of the inverter, it can be destroyed due to overvoltage. All warranty claims become void.
- ◇ Check the design of the PV plant. The Max. open circuit voltage, which can occur at solar panels ambient temperature of -10°C (14°F), must not exceed the Max. input voltage of the inverter.
- Before connecting PV panels to DC terminals, please make sure the polarity is correct. Incorrect polarity connection could permanently damage the unit. Check short-circuit current of the PV string. The total short-circuit current of the PV string should be less than the inverter's maximum DC current.
- Connect the positive and negative terminals from the PV panel to positive (+) terminals and negative (-) terminals on the PV-Inverter. Each DC terminal on Inverter can withstand 20Adc.

Technical Advice / Application Assistance: +1 (903) 441-2090

- For instance, if the positive pole of a string is connected at MPP tracker A and the string's negative pole at MPP tracker B, this is called a mixed connection, the inverter no longer fulfills the requirements of the EMC Directive.
- Only connect strings at one input zone and never mix the input zones A and B!
- High voltages exist when the PV panel is exposed to the sun. To reduce risk of electric shock, avoid touching live components and treat connection terminals carefully.

6.6.2. Wiring Step

1. Open the independent DC (disconnect) separate unit, the DC switch on the Growatt MTLP-US inverter and the AC separate unit.

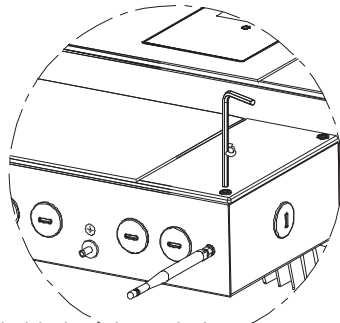

2. Open the left hand side knock-out hole.

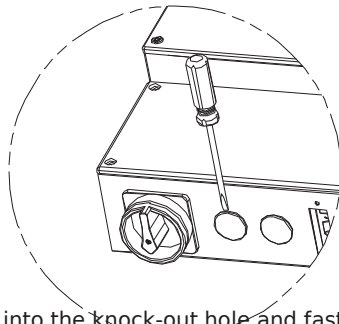

3. Install rubber pipe into the knock-out hole and fasten the pipe nut, feed the cables through the pipe into the wire box to DC terminal.

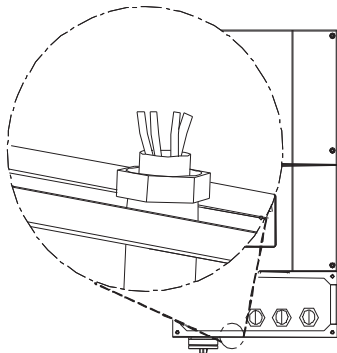

4. Connect the PV cables to the terminal correctly.

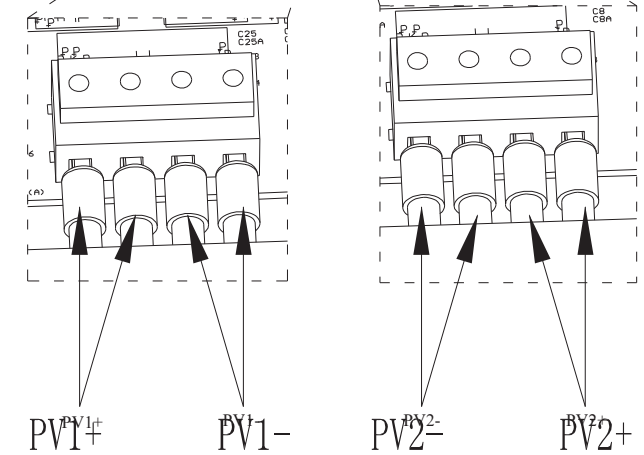

5. Check the wiring of PV positive and negative connection is correct polarity then turn on DC switch.

NOTE: When DC disconnect is turned off, PV wiring mistake (polarity reverse) the wire box board LED light will brighten.

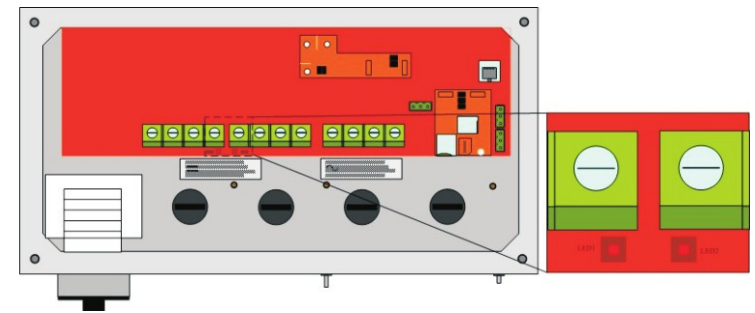

6. Verify that all connections are correctly cabled and tightened to the correct torque. Pull on the cable in order to make sure that it is attached tightly enough in the terminal.

7. The DC cables are connected in the wire box.

6.7. Communication connection

6.7.1. RS485 cable connection

1. Install the rubber pipe into the knock-out hole and fasten the pipe nut, feed the RS485 cables through the pipe into the wire box.
2. The RS485 bus line is recommended not exceed 0.5mile when using the #20AWG RS485 communication stander line. Shielded twisted pair cable (STP), impedance 100~150 ohm is recommended.



Code	Name	Detail
A	Conductor cross-section	0.2~0.5mm
B	Stripping insulation	0.2~0.3inch

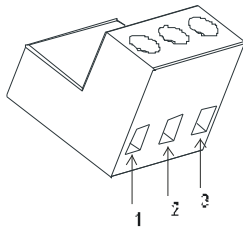

3. Remove the RS485 connection terminal from accessory packing bag.

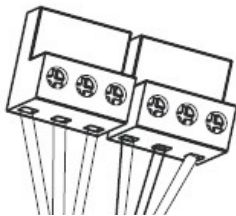

4. Connect the cable to the RS485 terminal ('1' to 'T/R-', '3' to 'T/R+', and '2' to the shielding net)



5. Plug RS485 terminals into the inverter

 Information	<p>As to the connection between inverters, please refer to the following figure.</p>
 Information	<p>As to the connection between inverter and data logger, please refer to the following figure.</p>
 Information	<p>RS485 BUS balance jumper: In RS485 communication circuit, when the T/R+ and T/R lines reach a certain length, the line itself has impedance, in order to balance the impedance of the RS485 bus line, you'd better get the jumper to the state 'ON' in RS485 BUS balance jumper of the remote inverter that the last one connects to the RS485 bus line while others keep 'OFF' state.</p>

Inverter

6.7.2. Ethernet cable connection

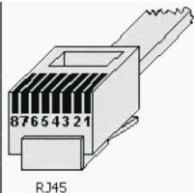

1. Install a rubber pipe into the knock-out hole and fasten the pipe nut, feed the Ethernet cables through the pipe into the wire box.
2. Ethernet communication wiring request and machining.
3. Using CAT5 cable for monitoring connections, connect RJ45 plug to the end of the cable as shown in the following table and plug into RJ45 jack.

	PIN	Signal name	Description
	1	TX+	Transmit Data
	2	TX-	Transmit Data
	3	RX+	Receive Data
	6	RX-	Receive Data
	4,5,7,8	N/U	NA

6.7.3. Antenna installation

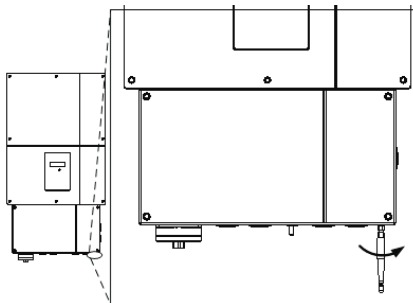
Inverter model using internal wireless module, antenna installation as follows:



 DANGER	High voltages in the PV system Risk of death or serious injury due to electric shock. • Only electrically skilled persons may perform work on the PV array.
 WARNING	• Under any condition! Make sure the maximum open circuit voltage (Voc) of each PV string is less than 600VDC.

Requirements:

- ✓ The AC cable is correctly connected.
- ✓ Ensure DC cable is correctly connected.
- ✓ Cover the wire box.
- ✓ Close the separate DC disconnect unit and the DC disconnect on the inverter.
- ✓ When the PV modules are connected and PV voltage is greater than 100 Vdc but the AC grid is not yet connected, the message on the LCD display produce the following messages in order: 'PV Inverter' -> 'Waiting' -> 'No AC connection'. The display repeats 'No AC connection' and the LED will be red.
- ✓ Setting grid model choice. See the chapter 8.2 'Setting the LCD display'.
- ✓ Close the AC separate unit between inverter and grid. The normal operating sequence begins.
- ✓ Under normal operating conditions the LCD displays 'Power: xxxx.xW xxxx.xVar'. That is the power fed to the grid. The LED turns green.
- ✓ This completes the check.

Technical Advice / Application Assistance: +1 (903) 441-2090

8 Display

8.1. LCD display

Start-up display sequence, once the PV power is sufficient, the inverter displays information as shown in the flow chart as follow:

Module: xxxxxx
 Ser No: xxxxxxxxxx
 FW Version: x.x.x
 Connect in: xxxS
 Connect: OK
 Power: xxxx.xW xxxx.xVAr

The LCD display's back-light automatically turns off after 30 seconds to save the power. The display on the inverter can be controlled by knocking on the front of it.

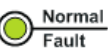
Symbol	Description	Explanation
	Tap symbol	Indicates display operation
	Inverter status symbol	Indicates inverter operation status

➤ The first line will show some status of the inverter, there are 4 status listed in below table.

The First Line Of LCD		
STATE	DISPLAY CONTENT	REMARK
Wait State	Standby	PV voltage low
	Waiting	Initial waiting
	Connect in xx S	System checking
	Reconnect in xx S	System checking
Inverter State	Connect OK	Connect to Grid
	Power: xxxx.x W xxxx.xVA	Inverter watt at working
Fault State	Error: xxx	System Fault
Program State	Programming	Update Software

➤ The Second line can change by knock on.

The Second Line Of LCD		
Cycle display	Display time/S	Remark
2279.5W 12.4VAr Model:PVIA00F163	2	The inverter model
1872.0W 25.4VAr FW Version:IA1.0	2	The software version
2270.0W 14.3VAr SerNo:xxxxxxxxxx	2	The Serial Number
4240.1W 75.4VAr Etoday: 12.7KWh	4	The energy today
1270.0W 75.4VAr Eall: 102.1KWh	4	The energy all
743.7W 20.3VAr Ppv: 421/ 389 W	4	PV input watt
427.3W 15.7VAr PV:387/389 B:389	4	The PV and Bus Voltage
3724.3W 10.1VAr AC:217V F:60.1Hz	4	Grid information
3143.7W 20.3VAr L1:119V L2:120V	4	The grid system
2635.1W 10.3VAr Setting	4	Setting
2521.7W 11.3VAr 2014/12/05 11:20	4	Time system
2324.5W 16.7VAr AC Error Record	4	The last 5dated failure report
2635.1W 10.3VAr Input 123: xxx	4	Set input page
2635.1W 10.3VAr Language:English	4	language

Technical Advice / Application Assistance: +1 (903) 441-2090

Cycle display	Display time/S	Remark
2635.1W 10.3Var Set Language	4	Set language
2635.1W 10.3Var COM Address: xxx	4	Set Communications Address
2635.1W 10.3Var Net model: x	4	Set Net Model
2635.1W 10.3Var Zigbee: xxxxxxxx	4	Zigbee status

8.2. Setting the LCD display

The inverter can support three types of knocks: single knock, double knock and triple knock. Each type of knock has different function. Refer to specified definition in Table below :

Knock type	Definition
Single knock	Key Down
Double knock	Key SET
Thrice knock	Key Enter or ESC

Before light the background, the types of knock functions are the same: just light the background.

NOTE : That the background light will automatically off if there is no knock detected in 10 seconds.

Sound control can define the display language, communication address and utility model choice.

8.2.1. Read AC Error record information

When the LCD is dark, a knock and double knock will activate LED. Knock to change the situation, enter to 'AC Error record' page. Double knock to information read state, Display show as follows :

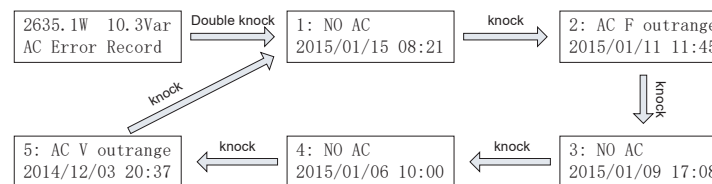

8.2.2. Enter to set

When the LCD is dark, a knock and double knock will activate LED. Knock to display next information or change the set situation. Double knock makes the display stand for 30 second, enter to setting state. Display show as follows :

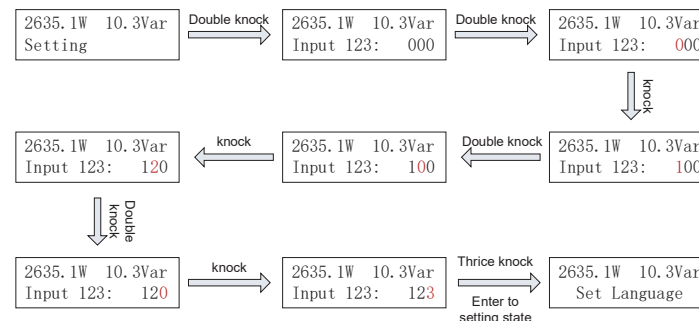

8.2.3. Setting language

On the set situation page → knock to 'Set language' → double knock to enter 'language: English' → knock to select the language you need and triple knock to enter or wait until the display become dark.

8.2.4. Setting communication address

On the set situation page → knock to 'COM Address: xx' → double knock to change the Address model → knock to set address, triple knock to enter or wait until the display become dark.

8.2.5. Setting grid model choice

This function is disabled when the inverter work in the normal state, you must turn off the AC (disconnect) separate unit, and the inverter LCD will display an error 'NO AC Connection', LED turns red, then this model choice function is enable. On the set situation page → knock to 'Set Grid type' → double knock to enter 'Grid Tx: xxxV' → knock to select the grid model .need to wait for 10S till the LCD background light gone out then the inverter will automatically restart. Turn on the AC (disconnect) separate unit, inverter will operate.

8.2.6. LED

The LED also represents the status of the inverter.

LED color /status	Inverter status
Green/constant	Operation
Red/constant	" Fault-- contact installer Standby model "
Red/flashing	Software update

8.3. Operation checking

1. Remove all covers from the PV array.
2. Switch on the AC breaker.

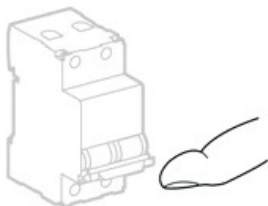

3. Turn the DC Disconnect to position 'I'.

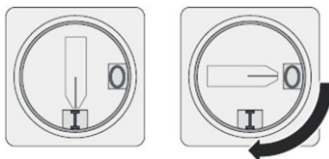

4. If the PV voltage input is between 120V-150V, the inverter will work in a standby status. If the PV voltage is between 150V-600V, the inverter will work in a normal status. So you can check the information as well as the status on the LCD.
5. Once the inverter is working in a normal status, before parallel in the grid, it will take 30 seconds to check the inverter. The LCD First line's information as follows:

Connect in 30S
XXXXXXXXXXXXXXXXXX

6. When it counts to 0s, the inverter begins to parallel in the grid. Once it feeds to the grid successfully, the First line in the LCD will show as follows:

Connect OK
XXXXXXXXXXXXXXXXXX

And the LED will turn to green.

7. The Growatt MTLP-US feeds to the grid successfully!

9.1. Monitoring

Related cables should be connected before you start to monitor, please ref Chapter 6.7.

9.1.1. Using Shine net to monitor the inverter

Shine NET is PC software that communicates with inverter to analyze the inverter working state. It is convenient for you to know the inverter's real-time working state and the history work information.



Features:

- Monitor and record current data and of inverters
- Record historical data.
- Monitor and record event information of inverter
- Connect computer and inverter via RS485 port
- Remote access available for local area network.

 Information	Users are able to monitor the inverter after the setting of software. Detailed information about setting and functions refer to the Shine NET Manual. You can download the Shine Net YN2.0 from: ftp://202.105.137.83 , the user name is <code>ftpguest</code> and Password is <code>ftpguest</code> . Shine Net may be upgraded for better function or user experience, Please refer to the actual software version.
--	--

Technical Advice / Application Assistance: +1 (903) 441-2090

9.1.2. Shine link system

Shine Link is a new product designed to monitor and manage your PV system, storage system, heating system and EV charging system at the same time maximize self-consumption of solar energy. For example, it can also switch off targeted consumers at low solar generation to reduce electricity bills. Shine Link collects data and uploads information over the internet in near real-time to Growatt Shine Server platform and keeps user informed of the system's status at any time. Shine Server provides real-time access to your electricity consumption and solar generation data through your web browser, smart phone or tablet. Together with Growatt Shine Server, Shine Link offers a smarter way of managing your home energy over the internet whenever, wherever and however you want.



Shine link box

9.1.3. Shine Webbox

Shine Web-Box is specially designed for solar power plant remote monitoring. While supporting both wired and wireless communication, Shine Web-Box can simultaneously monitor, record and analyze inverter operating parameters real-time with a maximum quantity of 50. Monitored data can be sent to Shine Server.

Please ref to Shine Web-box manual



Shine WebBox

9.1.4. Wi-Fi module

Wi-Fi module is a wireless device used to monitor inverter. It transmits the data collected from the inverter to the server via router. User could get access to the inverter data by accessing the server.



WiFi module

9.1.5. Shine link RF module

Shine link RF module and shine link box with the monitor and the manage system. RF module is a wireless device, It transmits the data collected from the inverter to the shine link box.

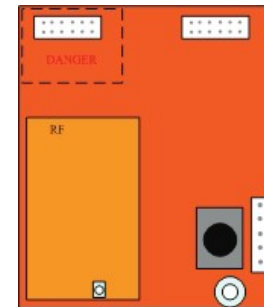

Shine link RF module

9.1.6. Zigbee module

Zigbee module is a wireless device, meet SunSpec protocol. It transmits the data collected from the inverter to the server via router. User could get access to the inverter data by accessing the server.



Danger to life from electric shock due to high voltages
Zigbee module top left corner with high voltage, don't touch.

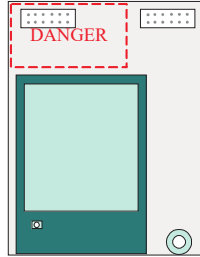

Zigbee module

9.1.7. 3G module

3G module is a wireless device, which meets SunSpec's communication protocol. It transmits the data collected from the inverter to the server via router. User could get access to the inverter data by accessing the server.



Danger to life from electric shock due to high voltages
3G module top left corner with high voltage, don't touch.

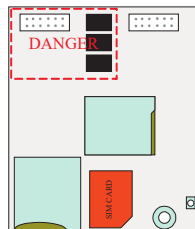

3G module

9.1.8. Shine Server

Shine Server is a remote data server, it is based on B/S structure. It can receive monitoring data from Shine Web-box, and publish monitored data to LAN or WAN. User can easily access data browse interface via an Internet Explorer.

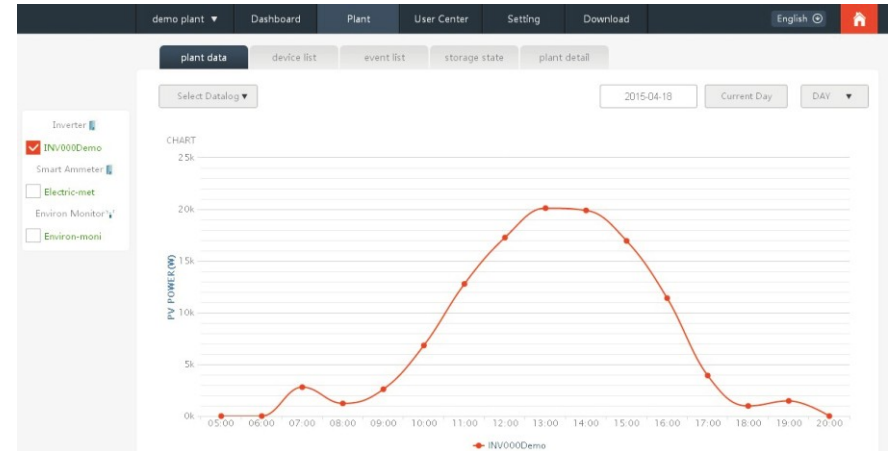

9.2. Monitoring System

The inverter provides a Multi communication optional mode :

- Cable communication mode
 - There are two kinds of cable communication mode: RS485 and Ethernet. RS485 as the inverter model standard, Ethernet as the inverter model optional function.
- Wireless communication mode
 - There are four kinds of wireless communication module: shine link RF, Wi-Fi, Zigbee and 3G . Wireless communication as the user matching function.

9.2.1. RS485 monitoring system

RS485 interface to communicate with remote PC or logger. User can monitor the inverter's state via the following types of communication systems.

- Through RS485 interface- RS485-232 converter +PC monitor single inverte

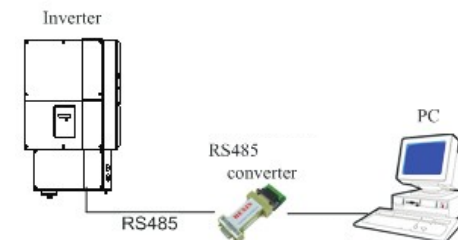

Technical Advice / Application Assistance: +1 (903) 441-2090

- Through RS485 interface-data logger +PC monitor single inverter

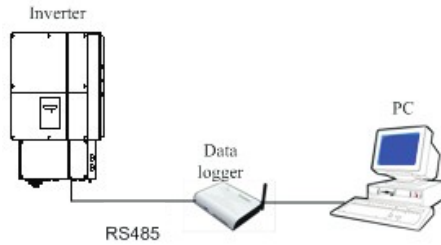

9.2.2. RS485 and Ethernet monitoring system

- Through RS485 interface +Ethernet monitor single inverter

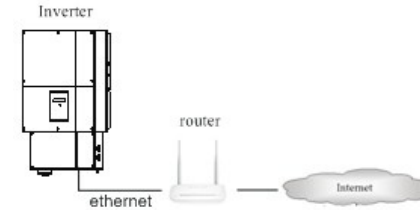

- Through RS485 interface-Data logger monitor Multiple inverters

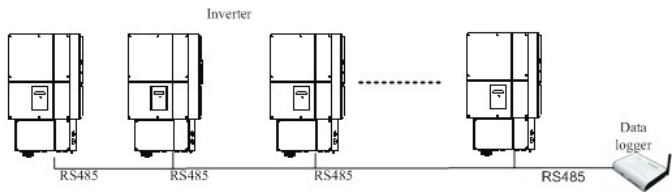

- Through Ethernet monitor Multiple inverters

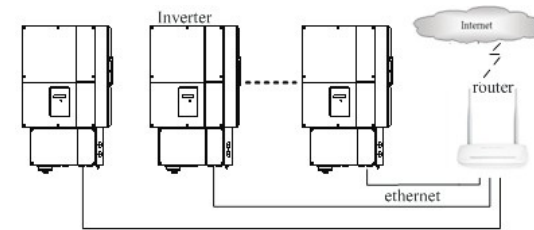

- Through RS485 interface-Data logger+ PC monitor Multiple inverters

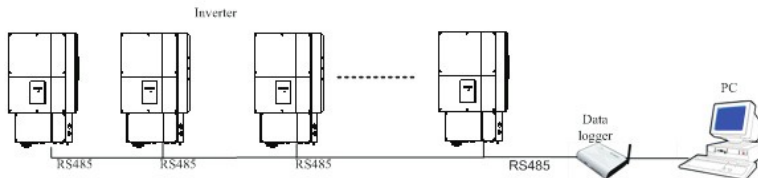

9.2.3. Wi-Fi communication monitoring system

Wi-Fi Wireless communication mode limit as follows

- Through RS485 interface-RS485-232 converter+ PC monitor Multiple inverters

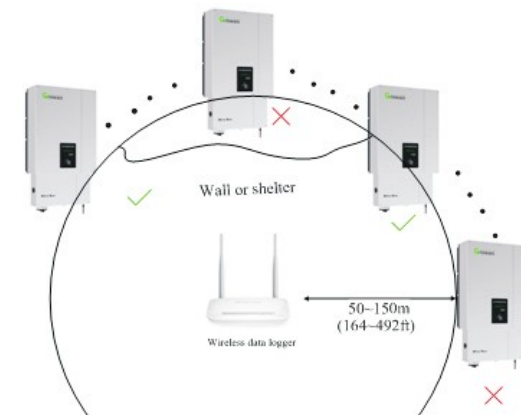
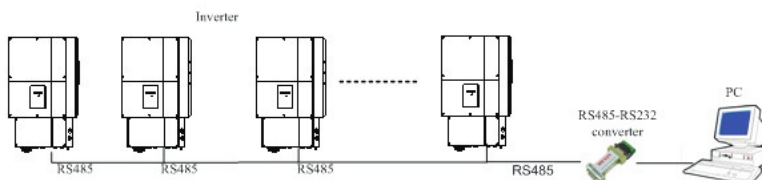

Integrated RF or wi-fi module

9.2.4 . Communication monitoring system

ZigBee Wireless communication mode limit as follows:

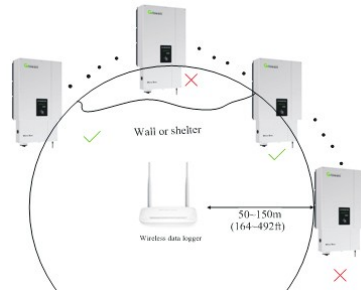
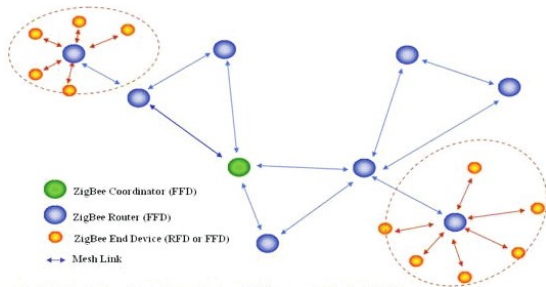

Integrated Zigbee module

9.2.5. 3G communication monitoring system

3G wireless communication distances depends on the position of network operators to communication base station (BTS) or occluded objects.

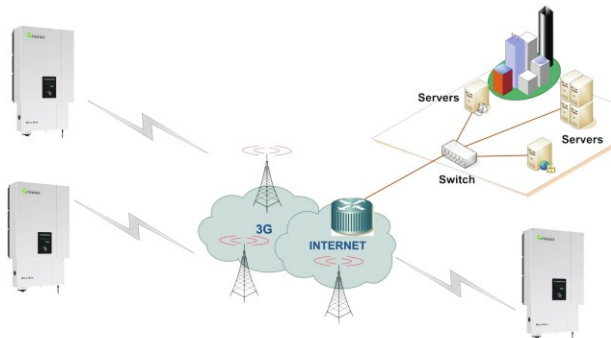

Integrated 3G module

10.1. Startup of the inverter

If the inverter regularly reduces its output power due to high temperature, please improve the heat dissipation condition. Maybe you need to clean the heat sink.

 WARNING	<ul style="list-style-type: none"> Make sure the Growatt MTLP-US has connected DC and AC cables correctly according to the wiring diagram of section 6 Under any condition! Make sure the maximum open circuit voltage (Voc) of each PV string is less than 600VDC.
--------------------	---

Turn on the DC switch, and the inverter will start automatically when the input voltage is higher than 150V.

- Turn the rotary switch from the off position '0' to the on position 'I' as following picture.

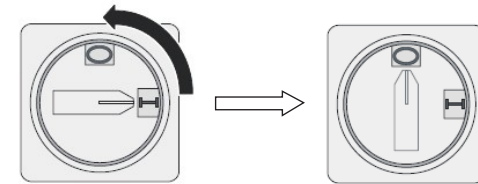

- Until the second line of LCD shows information as follows in proper sequence:

PV Inverter
SerNo:xxxxxxxxx

PV Inverter
Model:xxxxxxxxx

PV Inverter
FW Version:xxxxx

- And then LCD will show the information and the LED will turn to red:

No AC Connect
xxxxxxxxxxxxxxxxx

- So you have to turn on the AC connector.

- Once the inverter is working in a normal status, before parallel in the grid, it will take 300 seconds to check the inverter include the GFCI automatically.

- When it counts to 0s, the inverter begins to parallel in the grid, and the LED will turn to green.
- Booting the Growatt MTLP-US successfully!

10.2. Turn off the Growatt MTLP-US

- Turn the PV side current breaker to position '0'

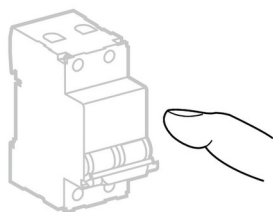

- Turn the rotary switch from the On position 'I' to the Off position '0' as following picture.

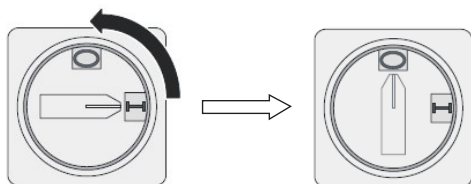

- Wait until the text line of the LCD shows:

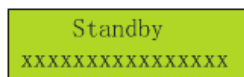

And the LED will turn to red.
In this state, it is working in a standby module from the grid power.

- Turn off the AC connector until the LCD and the LED are blanked.
- Shutdown the Growatt MTLP-US successfully!

11.1. Checking the inverter

Ask the installer to check for correct inverter operation at regular intervals.

Check whether there is any visible damage to the inverter.

If there is any external visible damage to the inverter, contact the installer.

11.2. Checking the DC disconnect

Checking externally visible damage and discoloration of the DC disconnect and the cables at regular intervals. If there is any visible damage to the DC disconnect, or visible discoloration or damage to the cables, contact the installer.

Once a year, turn the rotary switch from the 'On' position to the 'Off' position 5 times in succession. This cleans the contacts of the rotary switch and prolongs the electrical endurance of the DC disconnect.

11.3. Cleaning the Inverter

If the inverter is dirty, shut down the inverter, clean the enclosure lid, the display, and the LEDs using only a wet cloth. Do not use any cleaning agents (e.g. solvents or abrasives).

 WARNING	For safety, do not open wire box until 20 minutes passed.
-------------	---

11.4. Trouble shooting

Sometimes, the PV inverter will not work as normal, we recommend the following solutions for common trouble shooting. The following table can help the technician to understand the problem and take action.

11.4. 1. Warnings (W)

Warnings (W) identify the current status of the Growatt MTLP-US inverter.

Warnings do not relate to a fault. When a (W) with a number after it appears in the display, it indicates a Warning Code and is usually cleared through an orderly shutdown/re-set or a self corrective action performed by the inverter. See the (W) codes in the following table.

Technical Advice / Application Assistance: +1 (903) 441-2090

Error message	Description	Suggestion
Warning103	Fail to read EEPROM.	Restart the inverter
Warning104	DSP and COM firmware version unmatched	Update program
Warning105	Fail to write EEPROM.	Restart the inverter
No AC Connection	No utility grid connected or utility grid power failure.	1. Check AC wiring and switch state, especially the ground wire. 2. Clear malfunction, Restart inverter.
AC V Outrange	Utility grid voltage is out of permissible range.	1. Shunt down the inverter, check grid type and voltage. 2. Ensure NET model and voltage is right, restart inverter.
AC F Outrange	Utility grid frequency out of permissible range.	1. Check grid frequency range. 2. Restart inverter
Over Temperature	Temperature outrange	1. Check the inverter operation state 2. Lower ambient temperature, restart inverter.
PV Isolation Low	Insulation problem	1. Check if panel enclosure ground properly. 2. Check if inverter ground properly. 3. Check if the DC breaker gets wet. 4. Clear malfunction, restart inverter. 5. Clear the PV array firm and desiccate.
Output High DCI	Output current DC offset too high	Restart inverter.
Residual I High	Leakage current too high	Restart inverter.
PV Voltage High	The DC input voltage is exceeding the maximum value.	Disconnect the DC switch immediately.
 Information	If the error message is displayed despite the above checking suggestions passed, contact dealer or Growatt.	

➤ PV isolation detection

The ISO function is a protection mechanism. The inverter measures the resistances between both the positive pole and negative pole of PV panel and earth.

If either of the measured value is lower than the limit, the PV inverter will not connect to grid, the output relay will stay open, and show 'PV isolation low'. The limited value is determined by the standards.

The simplified principle of the isolation resistance measurement is described as below:

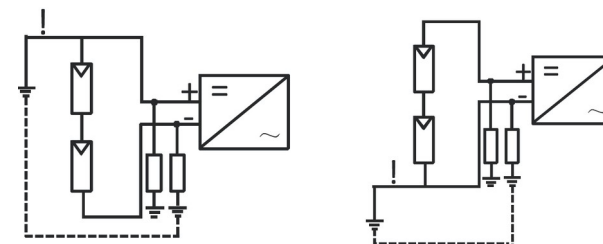

Note:

In the rain and snow weather or humid environment (humidity > 90%), PV panel array equivalent resistance less than the dry environment, the inverter may appear ISO error.

UL1741 require show as :

Inverter Maximum Power Rating	Minimum DC insulation resistance allowed between the PV array input(S) with respect to ground
≤ 5KVA	The larger resistance of 100k Ω or (1k Ω * Vmax)
> 5KVA	The larger resistance of 100k Ω or (5000 * Vmax) / (Smax)

➤ GFCI function

GFCI is short for Ground-Fault Circuit Interrupter which is used for preventing from being electric shock. The inverter is equipped with integrated RCD (Residual Current Protective Device) and RCM (Residual Current Operated Monitor). The current sensor will detect the volume of the leakage current and compare it with the pre-set value. If the leakage current is above the permitted range, the RCD will disconnect the inverter from the AC load.

11.4.2. Errors(E)

Errors (E) codes identify a possible equipment failure, fault or incorrect inverter setting or configuration. Any and all attempts to correct or clear a fault must be performed by qualified personnel. Typically, the (E) code can be cleared once the cause or fault is removed. Some of the (E) codes, Error as indicated in the table below, may indicate a fatal error and require you to contact the supplier to replace a new one.

Error code	Description	Suggestion
Error: 100	2.5V reference voltage fault	1. Restart inverter 2. If error message still exists, contact Growatt
Error: 101	Communication fault Slave processor can't receive data from Master processor.	1. Restart inverter 2. If error message still exists, contact Growatt
Error: 102	Consistent fault. Data received by Master and Slave processor are different. The reason can be utility grid voltage or frequency change frequently.	1. Restart inverter. 2. If error message appears frequently or error message still exists after replacement, check utility grid. if you require help, contact Growatt 3. If error message still exists, contact Growatt
Error: 111	Neutral to ground voltage high.	Check if system Neutral and ground properly
Error: 112	AFCI fault. System PV circuitry exist arc.	1. Check the system circuitry remove fault, restart inverter. 2. If error message still exists, contact Growatt.
Error: 114	AFCI Device Damage	Contact Growatt.
Error: 116	EEPROM fault	Contact Growatt.
Error: 117	Relay fault	Contact Growatt.
Error: 118	Init model fault	Contact Growatt.
Error: 119	GFCI Device Damage	Contact Growatt.
Error: 120	HCT fault	Contact Growatt.
Error: 121	Communication fault. Master processor can't receive data from Slave processor.	1. Restart the inverter 2. If error message still exists, contact Growatt..
Error: 122	Bus voltage fault	Contact Growatt.

12.1 Dismantling the inverter

- 1) Disconnect the inverter from any AC voltage sources (see Section 10).
- 2) Disconnect the DC Disconnect from PV array (see Section 10.1).
- 3) Open the wire box of the Growatt MTLP-US.
- 4) Remove all cables connected to the wire box.
- 5) Screw off all projecting cable glands.
- 6) Close the wire box.
- 7) Lift the inverter off the bracket and unscrew the bracket screws.

 DANGER	<p>Danger of burn injuries due to hot enclosure parts! Wait 20 minutes before disassembling until the housing has cooled .</p>
--	--

12.2 Packaging the inverter

If possible, always pack the inverter in its original carton and secure it with tension belts.

If it is no longer available, you can also use an equivalent carton. The box must be capable of being closed completely and made to support both the weight and the size of the inverter.

12.3 Storage of inverter

If you want to store the inverter the inverter in your warehouse, you should choose an appropriate location to store the inverter.

- The unit must be stored in original package and desiccant must be left in the package
- The storage temperature should be always between -25~ +60 °C (-13~ +140 °F). And the storage relative humidity should be always between 0 and 100%.
- If there are batch of inverters need to be stored, the maximum layers for original carton is six.
- After long term storage, local installer or service department of Growatt should perform a comprehensive test before installation.

12.4. Disposal

	<p>Do not dispose of faulty inverters or accessories together with household waste. Please accordance with the disposal regulations for electronic waste which apply at the installation site at that time. Ensure that the old unit and, where applicable, any accessories are disposed of in a proper manner.</p>
---	---

13.1 Normal Mode

In this mode, the inverter works normally and LED turns green.

Whenever the DC voltage is higher than 150Vdc, inverter converts power to grid as generated by the PV modules;

Whenever the DC voltage is lower than 150Vdc, the inverter will work in waiting state and attempt to connect the grid. In waiting state the inverter consumes just enough power generated by the PV panel to monitor the internal system status;



NOTE

The inverter starts up automatically when the DC power from the PV panel is sufficient.

13.2 Fault Mode

The internal intelligent controller can continuously monitor and adjust the system status. If inverter finds any unexpected conditions such as system fault and inverter fault, the fault information will be displayed on the LCD. In fault mode the LED turns red.



NOTE

Detailed fault information refers to 11.Trouble shooting.

13.3 Shutdown Mode

Inverters automatically stop running during periods of little or no sunlight. In shutdown mode the inverter takes no power from the grid or modules, and the LCD and LED turns off.



NOTE

If the PV string DC voltage is too low, the inverter will also turn to Shutdown Mode.

14.1 Altitude protect

The inverter uses natural convection cooling, if the installation site's altitude is greater than 2000 m, the inverter may trigger de-rating protection. Altitude and output

Power curves reference as follows:

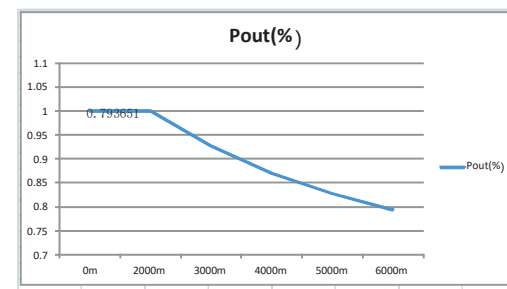

14.2 Temperature protect

The inverter will monitor the temperature of the heat-sink. Once the temperature exceeds 75°C (167°F), the system will reduce the output power until the temperature drops under the critical value. The inverter will shut down the power output to the grid if the temperature reaches 85°C (185°F). If this occasion happens often, it is necessary to check whether the inverter is mounted at an appropriate place with good ventilation and not directly exposure to the sunshine.

High temperature output Power de-rating curves reference as follows:

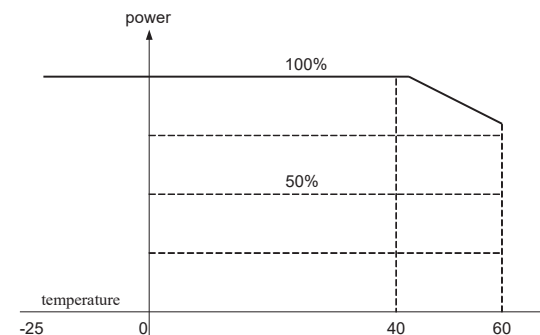

14.3 Arc detection protect and Operation

14.3.1.Arc-Fault message

Error NO.	Error description
Error 112	AFCI fault. System PV circuitry exist arc
Error 114	AFCI device damage.

14.3.2.Danger information

Then 'Error 112' Message is displayed and red LED is permanently lit and the buzzer alarms. An electric arc occurred in the PV system. The AFCI has tripped and the inverter is in permanent shutdown.

The product has large electrical potential differences between its conductors. Arc flashes can occur through air when high-voltage current flows. Do not work on the product during operation.

 <p>DANGER</p>	<p>Danger of fire from electric arc</p> <ul style="list-style-type: none"> • Only test the AFCI for false tripping in the order described below. • Do not deactivate the AFCI permanently.
---	--

14.3.3. Operation step

When the inverter error 112, please according to the following steps.

a) Turn the DC Disconnect to position "0".



b) Turn the PV system AC Disconnect to position "0".

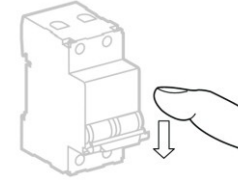

Wait for the display to go out.

c) Perform troubleshooting in the PV system :
Check all PV strings for the correct open-circuit voltage.

d) After the fault is rectified, restart the PV inverter :

e) Turn the AC Disconnect to position "1".

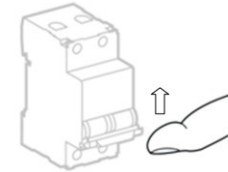

Turn the DC Disconnect to position "1".



The PV inverter starts and performs another AFCI self-test.

f) If the AFCI self-test is successful:
The PV inverter switches into the "nominal" mode and the green LED is permanently lit.

g) If the AFCI self-test fails:
The following message appears on the display : "Error 114."
Please restart the system, repeat step 1 to step 4.

h) If the AFCI self-test continues to fail:
Turn the DC Disconnect to position "0" and switch off the AC disconnect switch to the inverter.

14.3.4. Contact

If the AFCI self-test fails permanently. Please shutdown mode and contact the Service Line. Dealer information you can refer to the warranty card.

Please refer to the warranty card.

16 Technical Data

16.1 Specification

Model	4000 MTLP-US	5000 MTLP-US	6000 MTLP-US	7000 MTLP-US	7600 MTLP-US
Specifications					
Input data					
Max usable input current per MPPT(A)	18/18			20/10	20/10
Max short circuit input current per MPPT(A)	28/28			31/16	31/16
Max usable input current per inverter(A)	27	30	36	30	30
Max short circuit input current per inverter(A)	42	47	56	47	47
Startup voltage(V)	150				
Full power MPPT voltage range(V)	180-480			240-480	260-480
Max voltage(V)range)	600				
DC nominal voltage(V) MPP tracker	360				
DC voltage range(V)	100-600				
MPP operating voltage range(V)	120-500				
Max power per MPPT(W)	4000/4000	5000/5000	6000/6000	7000/4800	7600/4800
MPPT wired in parallel	yes/yes	yes/yes	yes/yes	yes/no	yes/no
Number of MPPT	2	2	2	2	2
Inputs per MPPT	2/2	2/2	2/2	2/1	2/1

Technical Advice / Application Assistance: +1 (903) 441-2090

Model	4000 MTLP-US	5000 MTLP-US	6000 MTLP-US	7000 MTLP-US	7600 MTLP-US
Specifications					
Output data					
Nominal power output(W)	4000	5000	6000	7000	7600
Continuous output power(W)	4000	5000	6000	7000	7600
Max usable input current per MPPT(A)	16.7	21	25	29	31.7
Peak efficiency	97.2%	97.5%	97.5%	97.4%	97.3%
CEC weighted efficiency	96%	96.5%	96.5%	97%	97%
Max over current protection device(A)	21	26	31	36	40
Operating frequency/ range(Hz)	60/59.5-60.5				
Default voltage type	240V split phase				
Operating voltage range(V)	211-264				
Optional voltage type	208V/240V/277V single phase				
Optional Operating voltage range(V)	183-228@208V/211-264V@240V/244-305@277V				
Ambient operating temperature range(full load)	-25..+45 °C / (- 13..+ 113 °F)				
abnormal voltage Clearing time adjust range	V<0.45Un; 0.16S±0.08S 0.45Un<V<0.6Un; ≤11S±0.2S 0.6Un<V<0.88Un; ≤21S±0.2S 1.1Un<V<1.2Un; ≤13S±0.2S V>1.2Un; 0.16S±0.08S				
abnormal frequency Clearing time adjust range	1# Under:56~60Hz/ ≤10S±0.08S 2# Under:56~60Hz/ ≤300S±0.8S 1# Over:60~64Hz/ ≤10S±0.08S 2# Over:60~64Hz/ ≤300S±8S				

Model	4000 MTLP-US	5000 MTLP-US	6000 MTLP-US	7000 MTLP-US	7600 MTLP-US
Specifications					
Output data					
Phase shift (cosφ)	Default:0.99,opt Reactive power adjust / range:-0.85~+0.85				
THDI	< 3%				
General Data					
Integrated disconnect	DC disconnect				
Arc-fault	standard				
DC reverse polarity protection	yes				
DC switch rating for each MPPT	yes				
Output overvoltage protection-varistor	yes				
Output over current protection	yes				
Ground fault monitoring for Split phase	yes				
Grid monitoring	yes				
Integrated all - pole sensitive leakage current monitoring unit	yes				
compliant to UL 1699B	yes				
Dimensions	28.74*15.75*8.46inch/730*400*215mm				
Weight	32Kg/70.5Lb				

Technical Advice / Application Assistance: +1 (903) 441-2090

Model	4000 MTLP-US	5000 MTLP-US	6000 MTLP-US	7000 MTLP-US	7600 MTLP-US
Specifications					
General Data					
Enclosure type	Type 4x				
Cooling type	convection				
Topology	Transformer-less				
Relative humidity	100% without condensation				
Altitude	Up to 2000m(6560ft) without power de-rating				
Noise emission (typical)	≤ 25 dB(A)				
Consumption: standby / night(with AC power supply)	< 5W / < 10W				
DC connection	Screw terminal				
DC terminal Max wire sizes	6AWG				
AC connection	Screw terminal				
AC terminal Max wire sizes	6AWG				
Smart meter for inverter	opt				
3G communication	opt				
display	LCD				
RS485/Shine link RF/WIFI/ Zigbee/3G/Ethernet	yes/opt/opt/opt/opt/opt				
Warranty: 5 years / 10 year	yes /opt				
Rapid Shutdown	external contactor junction box,				
Certificates and approval	UL1741,UL1998 ,IEEE 1547, CSA C22.2 No.107.1-1, FCC Part15(Class A&B),UL1699B				

16.2 Efficiency curve

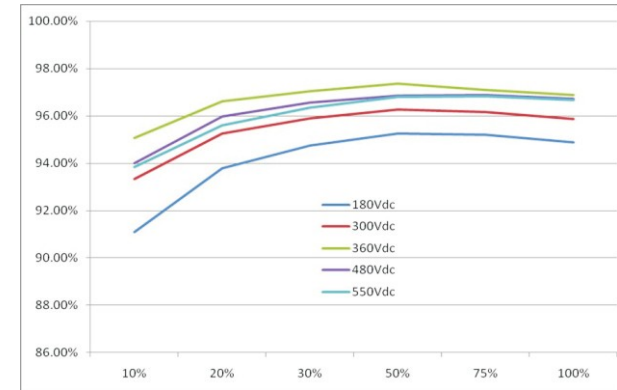

16.3 Torque

DC/AC terminal	1.2Nm(10 Lbf.in)
M6 socket head cap screws for securing the enclosure at the bracket	2Nm(18 Lbf.in)
Additional ground screws	2Nm(18 Lbf.in)

16.4 Optional

In the following table you will find the optional accessories or optional integrated function module for your product. If required, you can order these from SHENZHEN GROWATT NEW ENERGY TECHNOLOGY CO.,LTD or your dealer.

➤ www.ginverter.com/Download.aspx

Inverter optional accessories and function

Name	Brief description
WebBox	Data logger
Ethernet	Integrated function
Zigbee	Integrated Wireless communication module
3G	Integrated Wireless communication module
Wi-Fi	Integrated Wireless communication module
Meter	Integrated function
Shine link box	Energy monitoring and management system gateway
Shine link RF module	Integrated wireless Network accessories

Contact 18

➤ If you have technical problems about our products, contact the Growatt Service line. We need the following information in order to provide you with the necessary assistance:

- Inverter type
- Serial number of the inverter
- Event number or display message of the inverter
- Type and number of PV modules connected
- Optional equipment

Manufacturer:
GROWATT NEW ENERGY TECHNOLOGY CO.,LTD

Address:
No. 28 Guangming Road, Longteng Community, Shiyan, Baoan District,
Shenzhen, P.R. China

Service line
T: +86 755 2747 1942
F: +86 755 2747 2131
E: service@ginverter.com
W: www.growatt.com